

**acomax**   
*rolläden einfach elektrisch.*



# PRODUCT OVERVIEW

## 2023/2024

# FIVE FACTS FOR PRO- FESSIONALS



## SIMPLE

Simplicity is our primary principle, which is evident in all areas. Easy to use and easy to install products, simple instructions and much more. Put briefly, it is simple and fun to do business with us.



## COMPETENT

You understand your craft and that is why we are also craftsmen. Competent communication at eye level, because each of our employees knows our range of products and can answer most of your questions immediately and competently.



## RELIABLE

The brand acomax stands for products of high quality with a 5 year warranty given on motors and 2 year warranty given on controllers. In any case you can rely on what we promise.



## INNOVATIVE

If you want to be simple you have to be innovative. Because usually it is more difficult to leave something out than adding something. With us you will always be up to date because we regularly introduce you to innovations regarding the motorization of roller shutters and awnings.



## FAST

All orders that are placed before 3 p.m. will be dispatched on the same day. By doing this you can save money on high storage costs but still be very flexible and quickly operationally.

# CONTENT OVERVIEW ONE AFTER ANOTHER



## OVERVIEW

Modern product philosophy .....	4
Competent employees .....	5
The perfect drive .....	6
KLICK 2.0 system for roller shutter housing .....	8
KLICK 2.0 system for front-mounted box .....	10
Overview functions .....	13
Technical data .....	14
Deduction dimension .....	16
Motor choice .....	17
Electrical installation and connection .....	19



## MOTORS

<b>ANTRIEBE OHNE FUNK</b>	
MX-K Comfort motors .....	20
MX-N Emergency manual motors .....	21
MX-E Electronic motors .....	22
MX-Me Electronic motors for awnings .....	23
MX-Ze Electronic drives for Zip-Screen .....	24
MX-G DC motors .....	25
<b>DRIVES WITH BIDIRECTIONAL RADIO RECEIVER</b>	
MX-Fi Radio motors .....	26
MX-Nfi Manual motors with radio receiver .....	27
MX-I Radio motors with wifi module .....	28
MX-Mf Radio motors for awnings .....	29
MX-Zf Electronic wireless actuators for Zip-Screen .....	30
MX-Ga DC motors .....	31



## RADIO CONTROLS

Switches .....	33
Sun control systems & radio receivers .....	34
Portable- and wall-mounted emitters .....	35



## SMART HOME

SmartControl PLUS operating principle .....	37
Compability of unidirectional products .....	38
Compability of bidirectional products .....	39
SmartHome controls .....	40
FX-I 630 App operating principle .....	40



## ACCESSORIES

Brackets .....	44
Adapter sets .....	46
KLICK accessories for roller shutter housing .....	48
KLICK-Sets for roller shutter housing .....	49
KLICK accessories for front-mounted box .....	50
KLICK-Sets for front-mounted box .....	51
Other accessories .....	52
Shutter tubes accessories .....	53
Electric accessories .....	55
Emergency manual accessories .....	56
DC accessories .....	57



**MODERN  
PRODUCT PHILOSOPHY  
INNOVATIVE AND PIONEERING**



**LOGISTIC,  
QUALITY ASSURANCE,  
DEVELOPMENT, SALES  
AND TRAINING CENTER  
IN AICHTAL NEAR  
STUTT GART**

**MOTORIZATION-  
EXPERTISE AND  
FRIENDLINESS**

**PEOPLE MAKE THE  
DIFFERENCE**





# THE PERFECT DRIVE

INNOVATIVE, SILENT, STRONG, LONG LIVING, MAINTENANCE FREE



**Motorhead preinstalled in the factory,** either with **square bolt**  
10 x 10 mm standard delivery condition  
12 x 16 mm ZX-Z 512  
16 x 16 mm ZX-Z 516



**Metal plate** without square bolt



**Fast fixing KLIKK plate** for engage- and disengageable bracket WX-F 500



With **Starshaped-motorplate** ZX-Z 510

UNIQUE QUALITY PROMISE:  
**5 years warranty**

## FLEXIBLE MOTORHEAD

Mounting either with square bolt, metal plate, dovetail plate or starshaped-motorplate for ultra fast and flexible installation (more variations on request).

## CROWN ADAPTER

Solid part for easy mounting.

## LIMIT SWITCH

Intelligent, precise and superfast to adjust.

## CONSTRUCTION

Extreme compact.

## DRIVE

Absolutely reliable and 100% maintenance-free.

## BREAK

Reliable and low-noise.

## GEAR

Robust and super quiet.

## DRIVE ADAPTER

Very easy with one hand plugged and removable.



With integrated obstacle detection.

## COMFORTABLE RED SETTING TOOL

For easy and fast installation even in hard-to-access areas.

Plug into one another for extendable length.

## COMFORTABLE WHITE SETTING TOOL

## CABLE EXTENSION

On request for individual length with wire connector pre-installed in the factory.

On request **HIRSCHMANN CONNECTOR** Pre-installed in the factory.

## 2,5 m MOTOR CABLE

Standard cable length 2,5 meters.

## END POSITION SETTING

Via button on the motor or with programming cable.

## SETTING AND OPERATION

Wireless by radio or Smartphone.

# THE SHUTTER MOTOR INSTALLATION REVOLUTION KLICK 2.0

FOR WALL INTEGRATED SHUTTER BOXES

- ✓ **ULTRAFAST ASSEMBLY IN A FEW SECONDS.**
- ✓ **SNAP IN AND OUT EVEN AT WOUND ROLLER SHUTTER.**
- ✓ **IDEAL FOR CLOSED ROOM SIDE ROLLER SHUTTER BOXES WITH EXTERNAL INSPECTION.**



WWW.ACOMAX.DE/  
VIDEOS#KLICK

### FAST FIXING KLICK BRACKET

Engage and disengage the motor in the upper position.  
WX-F 500

### KLICK SPRING CROWN

Up to 7 cm telescopic.



### KLICK SPRING IDLER

With 12 mm bolt for ball bearing.

### KLICK COUNTERPART SUPPORT

With ball bearing for fast and easy installation.  
ZX-W 130

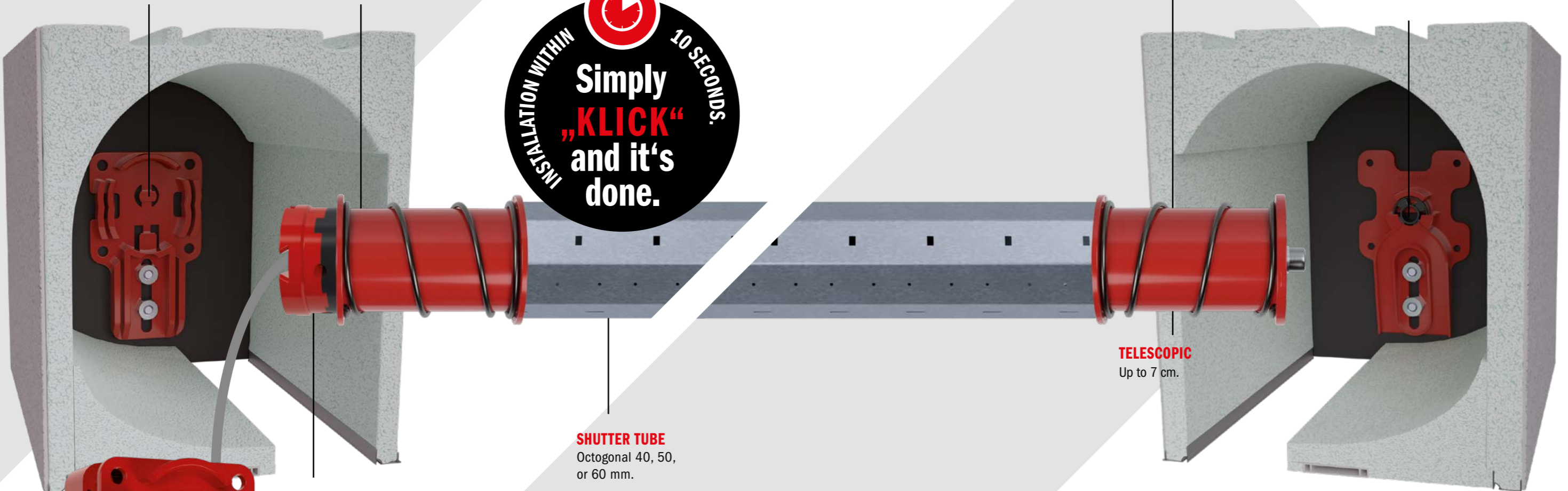

**TELESCOPIC**  
Up to 7 cm.

**SHUTTER TUBE**  
Octagonal 40, 50, or 60 mm.

### SPECIAL MOTORHEAD

For ultra-fast assembly.  
WX-F 500

### ADDITIONAL SPACE REDUCER OPENING

Thereby arbitrarily extendable, also for oversized roller shutter boxes in relation to the window. (Space gain per item: 3cm)  
WX-F 100



**KLICK SPRING CROWN**  
ZX-K 560 for 60 mm octagonal.

### KLICK SPRING IDLER COUNTERPART

ZX-K 640, ZX-K 650 and ZX-K 660 for 40, 50 and 60 mm octagonal.

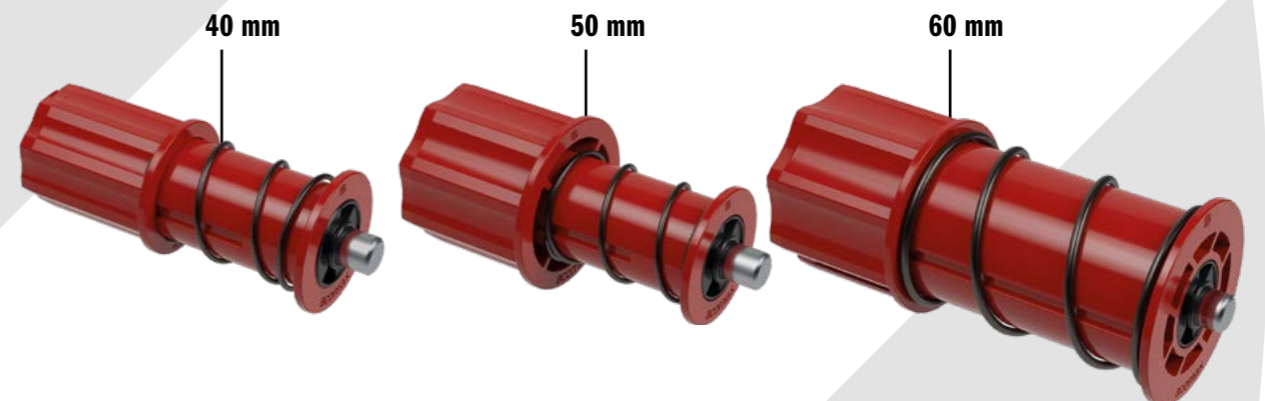



# THE SHUTTER MOTOR INSTALLATION REVOLUTION KLICK 2.0

FOR FRONT MOUNTED SHUTTER BOXES



- ✓ ULTRAFAST ASSEMBLY IN A FEW SECONDS.
- ✓ SNAP IN AND OUT EVEN AT WOUND ROLLER SHUTTER.



WWW.ACOMAX.DE/  
VIDEOS#KLICK

INSTALLATION WITHIN  
**Simply „KLICK“ and it's done.**  
 10 SECONDS.

**SPECIAL MOTORHEAD**  
For ultra-fast assembly.

**KLICK SPRING IDLER**  
With ball bearing.

**SHUTTER TUBE**  
Octagonal 40, 50 or 60 mm.

**TELESCOPIC**  
Up to 7 cm.

**FRONT-MOUNTED BOX**



**FRONT-MOUNTED BOX WITH KLICK-FRONT-MOUNTED-BRACKET**  
WX-V 505

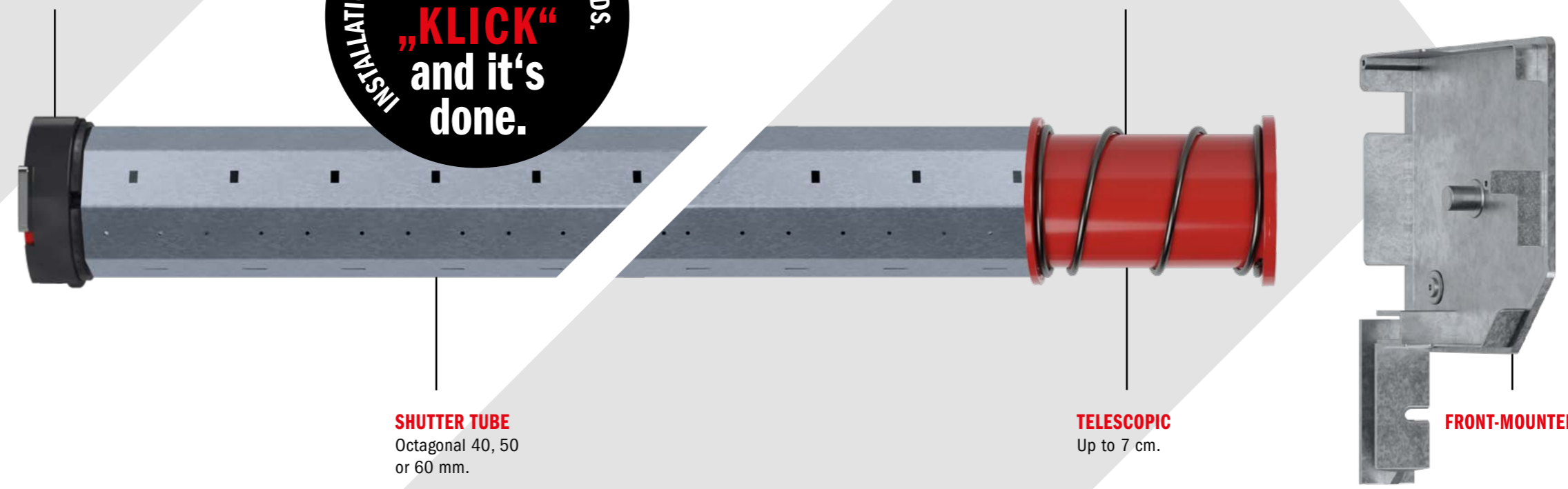

**TAB**  
For using also without front mounted box cover.



**MOUNTING CLIPS**  
For screwless mounting of the WX-V 505 in all external mounted shutter boxes of all manufacturer variants.

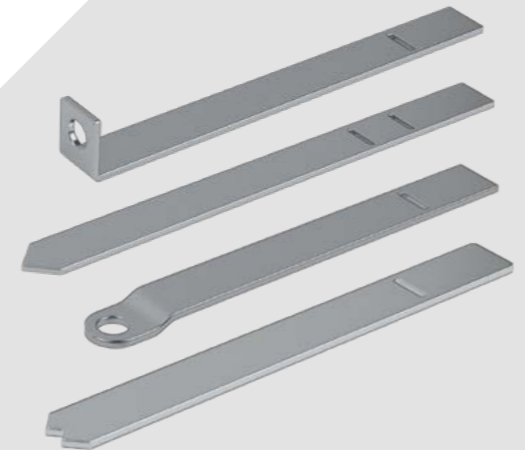

**KLICK SPRING IDLER COUNTERPART WITH BEARING**  
ZX-K 740, ZX-K 750 and ZX-K 760 for 40, 50 and 60 mm octagonal.



# THE PERFECT MOTOR

SILENT, LONG-LASTING,  
ROBUST AND UNIVERSALLY  
APPLICABLE!



## WHAT FUNCTION PERFORMS EACH MOTOR? IN ORDER TO MAINTAIN THE OVERVIEW.

UNIQUE QUALITY  
PROMISE:  
5 years  
warranty

Code MX-	Symbols	Drives without radio receiver						Drives with bidirectional radio receiver					
		Comfort	Manual motor	Electronic motor	Electronic awnings	Zip-electronic	DC motor	Radio	Manual radio motor	Radio motor with wiff module	Electronic radio awnings	Zip-radio	DC motor
		K	N	E	Me	Ze	G	Fi	Nfi	I	Mf	Zf	Ga
Power supply		230 V 50 Hz	230 V 50 Hz	230 V 50 Hz	230 V 50 Hz	230 V 50 Hz	12 V DC	230 V 50 Hz	230 V 50 Hz	230 V 50 Hz	230 V 50 Hz	230 V 50 Hz	12 V DC
Manual limit setting		•	•	-	-	-	•	•	•	-	-	-	-
Button limit setting		-	-	•	•	•	-	-	-	-	-	-	-
Emitter limit setting		-	-	-	-	-	-	-	-	•	•	•	•
End position adjustment via app		-	-	-	-	-	-	-	-	•	-	-	-
Connectable in parallel		-	-	•	•	•	-	•	•	•	•	•	-
Soft obstacle detection		-	-	•	-	•	-	-	-	•	-	•	-
Bidirectional radio		FX-E	FX-E	FX-E	FX-E	FX-E	ZX-G 620	•	•	•	•	•	•
WLAN receiver		-	-	-	-	-	-	-	-	•	-	-	-
Smart functions		FX-E	FX-E	FX-E	FX-E	FX-E	ZX-G 620	•	•	•	•	•	•
Manual override		-	•	-	-	-	-	-	•	-	-	-	-

Standard • not included - Only in conjunction with external receiver FX-E/ZX-G 620

### ADVICE

The proven unidirectional drives types MX-F, MX-R and MX-Nf are still available for a few months. Feel free to contact us for more information about current availabilities.

### SMART FUNCTIONS

Using the acomax app **SmartControl PLUS** or **SmartHome PRO** you can easily control your shading system via smartphone.

#### ACOMAX SMARTCONTROL PLUS

For installation in connection with the acomax **SmartControl PLUS** app you do not need any further components when using the MX-I drive. Otherwise only the **FX-I 610 Bridge Mini** or, if you are already using unidirectional acomax products, the **FX-I 620 Bridge Maxi** is needed.



Available on the  
**App Store**  
SmartControl PLUS App



Get it on  
**Google play**  
SmartControl PLUS App

# TECHNICAL DATA

TREMENDOUS PERFORMANCE FOR ALL DEVICES

ALL DRIVES 230 volt / 50 Hz, IP44, 2,5 m motor cable MX-G: 12 volt	TORQUE [NM]	NUMBER OF REVOLUTIONS [U./MIN.]	CURRENT [A]	POWER [W]	WEIGHT [KG]	DUTY CYCLE [MIN]	LIMIT SWITCH RANGE [UMDR.]
MX-K 410 MINI	10	17	0,53	121	1,66	4	17
MX-K 413 MAXI	13	14	0,53	121	1,82	4	41
MX-K 510 MICRO	10	15	0,53	122	2	4	17
MX-K 520 ULTRA	20	15	0,64	145	2,41	4	22
MX-K 540 MEGA	40	15	0,86	198	2,92	4	22
MX-K 550 GIGA	50	12	0,89	205	3,01	4	22
MX-K 560 TERRA	60	8	0,98	208	3,12	4	22
MX-K 680 XENO	80	12	1,71	396	5,37	4	23
MX-N 540 MEGA	40	15	0,86	189	3,78	4	23
MX-N 550 GIGA	50	12	0,89	205	3,80	4	23
MX-N 560 TERRA	60	8	0,92	208	3,98	4	23
MX-N 680 XENO	80	12	1,65	385	5,96	4	23
MX-E 413 MAXI	13	14	0,62	144	2,03	4	∞
MX-E 510 MICRO	10	15	0,48	113	2,15	4	∞
MX-E 520 ULTRA	20	15	0,69	161	2,76	4	∞
MX-E 540 MEGA	40	12	0,95	218	3,29	4	∞
MX-Me/f 540 MEGA	40	15	0,89	205	3,31	4	∞
MX-Me/f 550 GIGA	50	12	0,99	228	3,38	4	∞
MX-Ze/f 510 MICRO	10	15	0,48	113	2,15	4	∞
MX-Ze/f 530 SUPRA	30	15	0,79	185	2,76	4	∞
MX-Fi 413 MAXI	13	14	0,53	121	1,95	4	41
MX-Fi 520 ULTRA	20	15	0,64	145	2,71	4	22
MX-Fi 540 MEGA	40	15	0,86	198	3,17	4	22
MX-Fi 550 GIGA	50	12	0,89	205	3,26	4	22
MX-I 413 MAXI	13	14	0,62	144	2,02	4	∞
MX-I 520 ULTRA	20	15	0,69	161	2,80	4	∞
MX-I 540 MEGA	40	12	0,95	218	3,26	4	∞
MX-G 413 MAXI	13	13	2	45	1,35	4	41
MX-G 520 ULTRA	20	10	2,2	50,9	2,45	4	22
MX-Ga 413 MAXI	13	13	2	45	1,35	4	∞
MX-Ga 520 ULTRA	20	10	2,2	50,9	2,76	4	∞

DIAMETER A [MM]	SQUARE BOLT B [MM]	DEDUCTION DI- MENSION MOTOR- HEAD C [MM]	INSERTION D [MM]	OVERALL LENGTH E [MM]
35	13	20	386	419
35	13	21	499	533
45	13	16	339	368
45	13	20	463	496
45	13	20	530	563
45	13	20	530	563
45	13	20	552	585
55	17	22	563	602
45	13	28	591	619
45	13	28	591	619
45	13	28	609	637
55	17	27	609	636
35	13	18	579	610
45	13	18	383	414
45	13	18	602	633
45	13	18	650	681
45	0	20	650	683
45	0	20	650	683
45	0	20	590	610
45	0	20	590	610
35	13	21	581	615
45	13	21	602	636
45	13	21	631	665
45	13	21	631	665
35	13	18	580	611
45	13	18	602	633
45	13	18	652	683
35	11	15	577	604
45	13	20	643	680
35	13	18	579	610
45	13	18	634	665

**ATTENTION**  
Deduction dimension motorhead (C) depends  
on the motorhead.

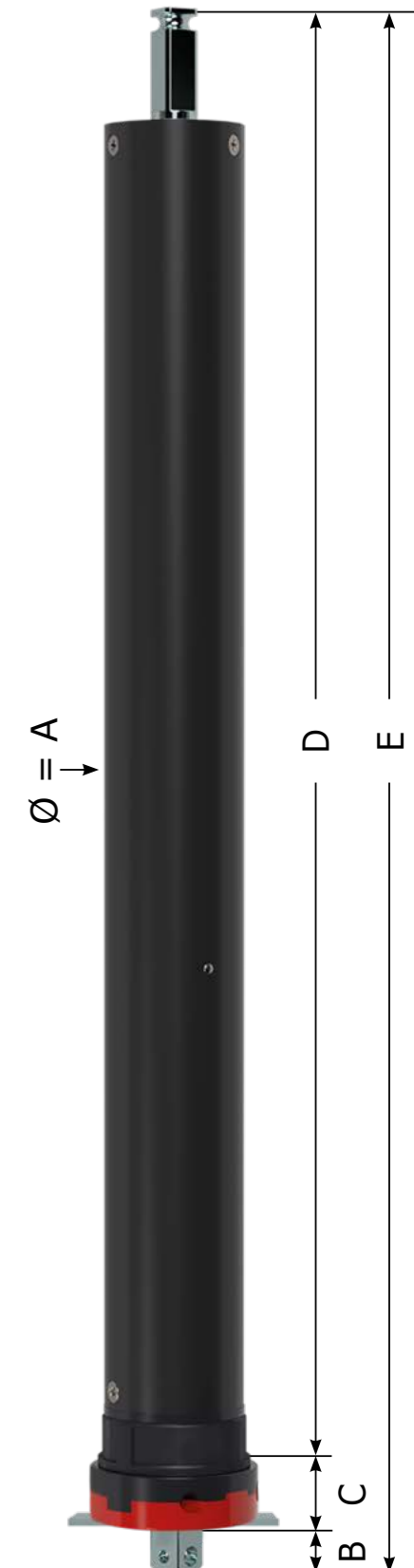



# DEDUCTION DIMENSION

## MOTORHEAD VARIATION // BRACKETS

### DEDUCTION DIMENSION

Depending on the components of motor head and brackets.

This table shows deduction dimension B



BRACKET	1. SQUARE BOLT (DELIVERY STATE)	2. METAL PLATE	3. FAST FIXING KLICK PLATE	4. STAR PLATE	5. STAR MOTORHEAD (MX-M/MX-Z)
WX-F 500			17 mm		
WX-F 511	12 mm				
WX-F 528				17 mm	17 mm
WX-F 531		3 mm			
WX-F 532	21 mm				
WX-F 533	8 mm				
WX-V 505		8 mm			
WX-V 520		3 mm			
WX-V 521		5 mm			
WX-V 528				17 mm	17 mm
WX-Z 510	13 mm				
WX-Z 528				17 mm	17 mm
WX-Z 535		3 mm			
WX-Z 540	18 mm				

OVERALL DEDUCTION DIMENSION = DEDUCTION DIMENSION BRACKET + DEDUCTION DIMENSION MOTORHEAD

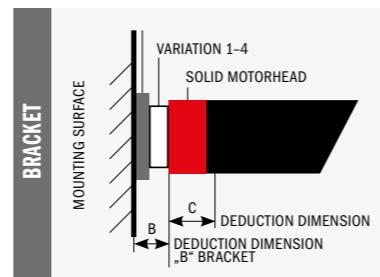

### MOUNTING VARIANTS

All motorhead options, preinstalled in the factory.

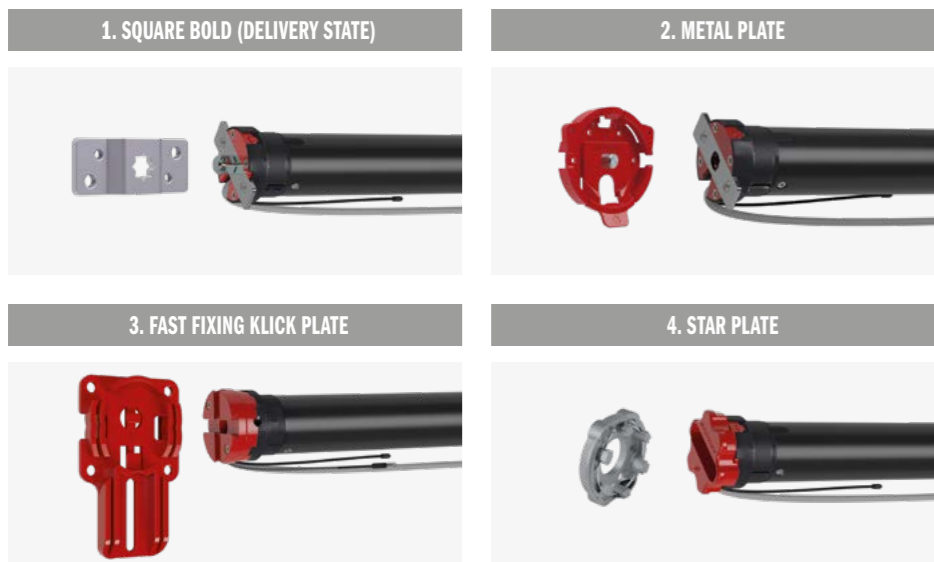

# WHICH MOTOR FOR WHICH APPLICATION?

## HOW POWERFUL THE MOTOR SHOULD BE

### SELECTION OF MOTORS FOR ROLLER SHUTTERS



MOTOR TYPE	TORQUE (NM)	SHUTTER TUBE	WEIGHT (KG)	MAXIMUM SHUTTER SIZE		
				PVC (M²)	ALU (M²)	WOOD (M²)
MX-410 MINI	10	40 mm	23	4,9	3,7	-
MX-413 MAXI	13	octagonal	30	6,6	5	-
MX-510 MICRO	10	50 mm octagonal	20	4,5	3,4	-
MX-520 ULTRA	20		45	10	7,5	-
MX-530 SUPRA	30		65	14	10,5	-
MX-540 MEGA	40		80	17,7	13,3	-
MX-550 GIGA	50		100	22,2	16,6	-
MX-510 MICRO	10	60 mm octagonal	18	3,9	2,9	-
MX-520 ULTRA	20		40	8,8	6,7	-
MX-540 MEGA	40		70	15,5	11,7	7
MX-550 GIGA	50		90	20	15	9
MX-560 TERRA	60		100	22,2	16,7	10
MX-540 MEGA	40	70 mm octagonal	60	13,3	10	6
MX-550 GIGA	50		75	16,7	12,5	7,5
MX-560 TERRA	60		90	20	15	9
MX-680 XENO	80		120	-	20	12

**BLIND WEIGHTS KG/M²:**  
 PVC: ca. 3,5-5 kg (Calculation basis 4,5 kg/m²)  
 Alu: ca. 5-7 kg (Calculation basis 6 kg/m²)  
 Wood: ca. 10 kg (Calculation basis 10 kg/m²)

### SELECTION OF MOTORS FOR AWNINGS



MOTOR TYPE	TORQUE (NM)	AWNING TUBE	FORCE (N)	ARMS (QUANTITY À 25 KG)
MX-520 ULTRA	20	63 mm notch	500	2
MX-540 MEGA	40		1000	4
MX-550 GIGA	50		1250	5
MX-520 ULTRA	20	70 mm notch	500	2
MX-530 SUPRA	30		750	3
MX-540 MEGA	40		1000	4
MX-550 GIGA	50		1250	5
MX-540 MEGA	40	78 mm notch	750	3
MX-550 GIGA	50		1000	4
MX-560 TERRA	60		1250	5
MX-560 TERRA	60	85 mm notch	1500	6
MX-540 MEGA	40		750	3
MX-550 GIGA	50		1000	4
MX-560 TERRA	60	85 mm notch	1250	5
MX-680 XENO	80		1500	6

**AWNING SPRINGS**  
 Strength per arm ca. 20-30 kg (Calculation basis 25 kg/arm).

UNIQUE QUALITY PROMISE:  
**5 years warranty**

# ALL DRIVES AND INSTALLATION

DRIVES WITH AND WITHOUT RADIO RECEIVER, BIDIRECTIONAL AND UNIDIRECTIONAL RADIO RECEIVER.



## ELECTRICAL CONNECTION FOR ALL DRIVES

### CONNECTIONS OVERVIEW

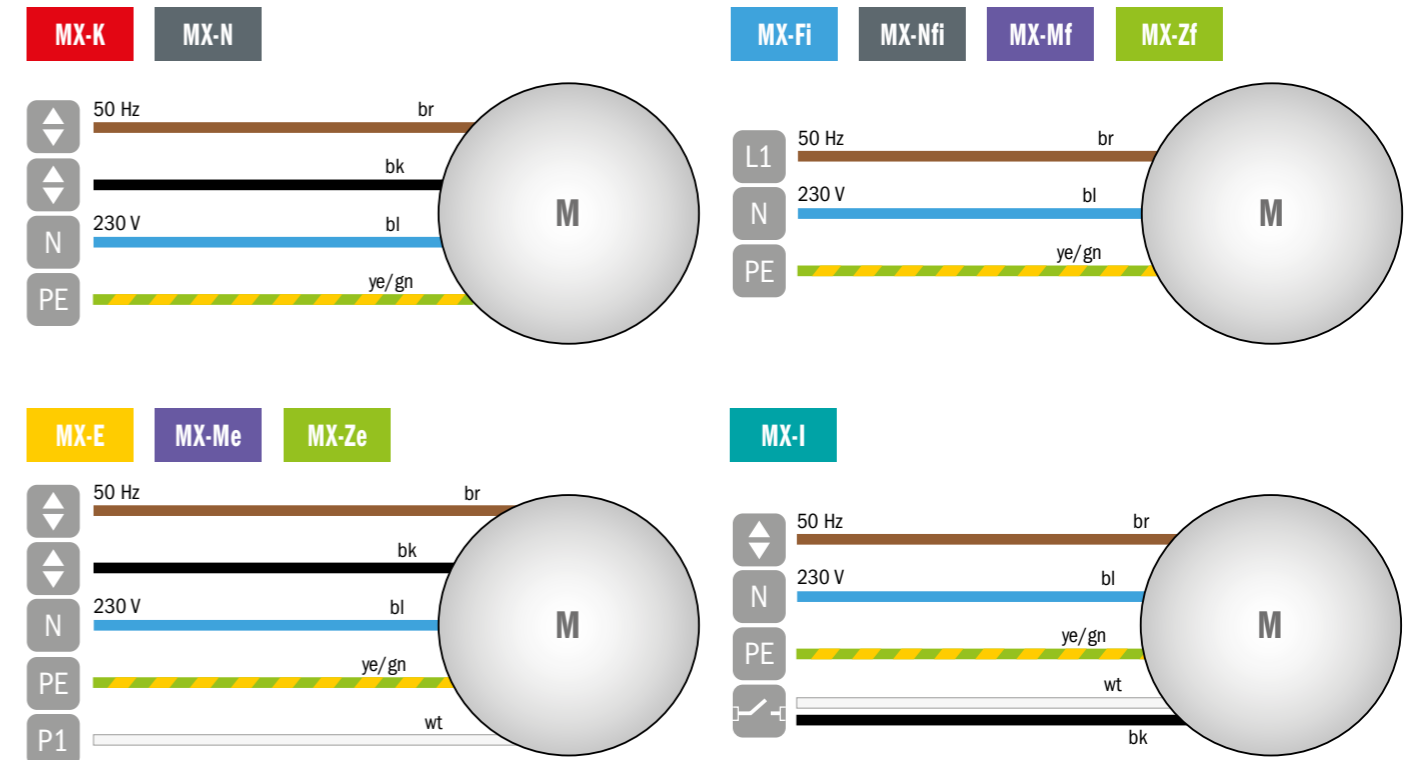

#### NOTE MX-E

The max. cable length must not exceed 20 meters. Otherwise, a group control must be used.

#### NOTE MX-I

Only after the end positions have been set can the 1-pole rocker switch be controlled via the black and white wires.

#### ATTENTION

Being in direct or indirect contact with live parts will cause a dangerous flow through the body. Electrical shock, severe burns or death can result. Installation and connection may only be carried by a licensed electrician! The tubular motors without appropriate electronics must not be connected in parallel (pay attention to max. switching capacity of the switching point).

Run all cables protected and firmly. Always lay the connection cable with a loop downwards so condensation water can not penetrate. Do not kink and make sure the cable cant be damaged by moving parts.

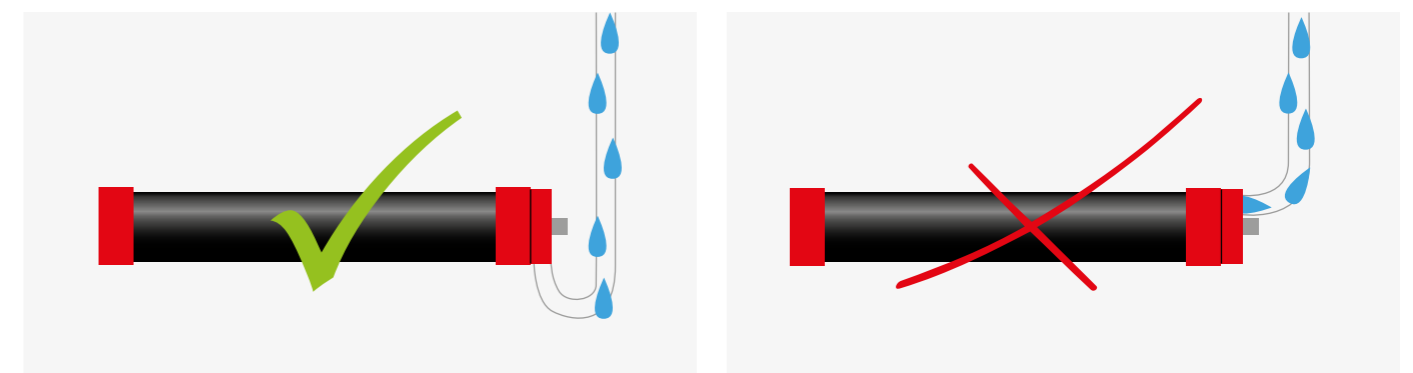





**THE CLASSIC VERSION – RELIABLE AND REASONABLE**

CODE	PRODUCT	DESCRIPTION
MX-K	<b>MX-K 410 Mini</b>	Tubular motor 10 Nm, 17 rpm., 40 mm octagonal, 2,5 m cable and standard engine mounts.
	<b>MX-K 413 Maxi</b>	Tubular motor 13 Nm, 14 rpm., 40 mm octagonal, 2,5 m cable and standard engine mounts.
	<b>MX-K 510 Micro</b>	Tubular motor 10 Nm, 15 rpm., 60 mm octagonal, 2,5 m cable and standard engine mounts.
	<b>MX-K 520 Ultra</b>	Tubular motor 20 Nm, 15 rpm., 60 mm octagonal, 2,5 m cable and standard engine mounts.
	<b>MX-K 540 Mega</b>	Tubular motor 40 Nm, 15 rpm., 60 mm octagonal, 2,5 m cable and standard engine mounts.
	<b>MX-K 550 Giga</b>	Tubular motor 50 Nm, 12 rpm., 60 mm octagonal, 2,5 m cable and standard engine mounts.
	<b>MX-K 560 Terra</b>	Tubular motor 60 Nm, 8 rpm., 60 mm octagonal, 2,5 m cable and standard engine mounts.
	<b>MX-K 680 Xeno</b>	Tubular motor 80 Nm, 12 rpm., 70 mm octagonal, 2,5 m cable and standard engine mounts.

Further information can be found in our 200-page DIN-A 5 Motorization Manual, in the section Drives (you may request your personal copy for free).

**SUITABLE ACCESSORIES**

CODE	DESCRIPTION	PAGE
<b>CX-G</b>	Group controls	35
<b>RX-S/R</b>	Switches and frames	35
<b>RX-T</b>	Timers	35
<b>ZX-K</b>	KLICK Installation System	50 – 53
<b>WX-F/V/Z</b>	Brackets	46 – 47
<b>AX-A/R</b>	Adapter-set	48 – 49



Illustrations may include optional equipment. If requested, we will be happy to assemble the motor head you need (standard delivery: with square bolt).



[WWW.ACOMAX.DE/VIDEOS#ANTRIEBE](http://WWW.ACOMAX.DE/VIDEOS#ANTRIEBE)



**THE SOLID VERSION – WITH MANUAL OVERRIDE**

ANTRIEB	PRODUCT	DESCRIPTION
MX-N	<b>MX-N 540 Mega</b>	Manual tubular motor 40 Nm, 15 rpm., 60 mm 2,5 m cable and standard engine mounts.
	<b>MX-N 550 Giga</b>	Manual tubular motor 50 Nm, 12 rpm., 60 mm 2,5 m cable and standard engine mounts.
	<b>MX-N 560 Terra</b>	Manual tubular motor 60 Nm, 8 rpm., 60 mm 2,5 m cable and standard engine mounts.
	<b>MX-N 680 Xeno</b>	Manual tubular motor 80 Nm, 12 rpm., 70 mm 2,5 m cable and standard engine mounts.

Further information can be found in our 200-page DIN-A 5 Motorization Manual, in the section Drives (you may request your personal copy for free).

**MANUAL – EVERYTHING UNDER CONTROL**

CODE	PRODUCT	DESCRIPTION
ZX-N	<b>ZX-N 510 Eye</b>	7 mm hexagon 11,5 cm long
	<b>ZX-N 511 Eye</b>	7 mm hexagon 28 cm long
	<b>ZX-N 520 Joint</b>	7 mm hexagon 50 cm long
	<b>ZX-N 530 Hand crank</b>	Collapsible handle 145 cm long



Illustrations may include optional equipment. If requested, we will be happy to assemble the motor head you need (standard delivery: with square bolt).



**SUITABLE ACCESSORIES**

CODE	DESCRIPTION	PAGE
<b>CX-G</b>	Group controls	35
<b>RX-S/R</b>	Switches and frames	35
<b>RX-T</b>	Timers	35
<b>WX-F/V/Z</b>	Brackets	46 – 47
<b>AX-A/R</b>	Adapter-set	48 – 49



[WWW.ACOMAX.DE/VIDEOS#ANTRIEBE](http://WWW.ACOMAX.DE/VIDEOS#ANTRIEBE)



**THE ELEGANT VERSION – LIMIT SETTING BY PUSHBUTTON**

CODE	PRODUCT	DESCRIPTION
MX-E	<b>MX-E 413 Maxi</b>	Electronic tubular motor 13 Nm, 14 rpm., 40 mm octagonal, 2,5 m cable and standard engine mounts.
	<b>MX-E 510 Micro*</b>	Electronic tubular motor 10 Nm, 15 rpm., 60 mm octagonal, 2,5 m cable and standard engine mounts.
	<b>MX-E 520 Ultra</b>	Electronic tubular motor 20 Nm, 15 rpm., 60 mm octagonal, 2,5 m cable and standard engine mounts.
	<b>MX-E 540 Mega</b>	Electronic tubular motor 40 Nm, 12 rpm., 60 mm octagonal, 2,5 m cable and standard engine mounts.



Illustrations may include optional equipment. If requested, we will be happy to assemble the motor head you need (standard delivery: with square bolt).

**ATTENTION! MX-E 510**

The tubular motor has only one mode, which is mode 3: No soft obstacle detection. No automatic limit setting.

Further information can be found in our 200-page DIN-A 5 Motorization Manual, in the section Drives (you may request your personal copy for free).

**SUITABLE ACCESSORIES**

CODE	DESCRIPTION	PAGE
<b>RX-S/R</b>	Switches and frames	35
<b>RX-T</b>	Timers	35
<b>ZX-K</b>	KLICK Installation System	50 - 53
<b>WX-F/V/Z</b>	Brackets	46 - 47
<b>AX-A/R</b>	Adapter-set	48 - 49



[WWW.ACOMAX.DE/VIDEOS#ANTRIEBE](http://WWW.ACOMAX.DE/VIDEOS#ANTRIEBE)



**THE SPECIAL VERSION – FOR CLOSED AWNING SYSTEMS**

CODE	PRODUCT	DESCRIPTION
MX-Me	<b>MX-Me 540 Mega</b>	Electronic tubular motor 40 Nm, 15 rpm, 78 mm notch, 2,5 m cable, star-motorhead and WX-V 528 engine mounts.
	<b>MX-Me 550 Giga</b>	Electronic tubular motor 50 Nm, 12 rpm, 78 mm notch, 2,5 m cable, star-motorhead and WX-V 528 engine mounts.



Further information can be found in our 200-page DIN-A 5 Motorization Manual, in the section Drives (you may request your personal copy for free).

Illustrations may include optional equipment. If requested, we will be happy to assemble the motor head you need (standard delivery: with square bolt).

**SUITABLE ACCESSORIES**

CODE	DESCRIPTION	PAGE
<b>RX-S/R</b>	Switches and frames	35
<b>WX-F/V/Z</b>	Brackets	46 - 47
<b>AX-A/R</b>	Adapter-set	48 - 49



[WWW.ACOMAX.DE/VIDEOS#ANTRIEBE](http://WWW.ACOMAX.DE/VIDEOS#ANTRIEBE)





**THE CONVENIENT - END POSITION ADJUSTMENT AT THE TOUCH OF A BUTTON**

**ELECTRONIC ZIP DRIVES** are used to motorize so-called zipper shades, which are provided with a kind of zipper and are therefore very stable in wind. The adjustment is made at the touch of a button or fully automatically. In addition, the drives have an intelligent obstacle/wind detection.

CODE	PRODUCT	DESCRIPTION
MX-Ze	<b>MX-Ze 510 Micro</b>	Elektronik Rohrantrieb 10 Nm, 15 U/Min., mit 78 mm Nutrohr Adapterset, 2,5 m Kabel und Stern-Motorlager
	<b>MX-Ze 530 Supra</b>	Elektronik Rohrantrieb 30 Nm, 15 U/Min., mit 78 mm Nutrohr Adapterset, 2,5 m Kabel und Stern-Motorlager

Further information can be found in our 200-page DIN-A 5 Motorization Manual, in the section Drives (you may request your personal copy for free).



Illustrations may include optional equipment. If requested, we will be happy to assemble the motor head you need (standard delivery: with square bolt).

**SUITABLE ACCESSORIES**

CODE	DESCRIPTION	PAGE
<b>RX-S/R</b>	Switches and frames	35
<b>RX-T</b>	Timers	35
<b>ZX-K</b>	KLICK Installation System	50 - 53
<b>WX-F/V/Z</b>	Brackets	46 - 47
<b>AX-A/R</b>	Adapter-set	48 - 49



[WWW.ACOMAX.DE/VIDEOS#ANTRIEBE](http://WWW.ACOMAX.DE/VIDEOS#ANTRIEBE)



**THE INDEPENDENT - FOR APPLICATIONS WITH 12 VOLT DC POWER SUPPLY**

CODE	PRODUCT	DESCRIPTION
MX-G	<b>MX-G 413 Maxi</b>	CD tubular motor 13 Nm, 13 rpm., 40 mm octagonal, with 2,5 m plug in cable for the ZX-G 620 accumulator.
	<b>MX-G 520 Ultra</b>	CD tubular motor 20 Nm, 14 rpm., 60 mm octagonal, with 2,5 m plug in cable for the ZX-G 620 accumulator.

Further information can be found in our 200-page DIN-A 5 Motorization Manual, in the section Drives (you may request your personal copy for free).



Illustrations may include optional equipment. If requested, we will be happy to assemble the motor head you need (standard delivery: with square bolt).

CODE	PRODUCT	DESCRIPTION
ZX-G	<b>ZX-G 610</b>	Solar panel dimensions 455 x 60 x 10 mm.
	<b>ZX-G 620</b>	Accumulator, 4.000 mAh with integrated radio receiver 433,92 MHz bidirectional dimension 585 x 27 x 27 mm.
	<b>ZX-G 650</b>	Battery charger with 1,5 m cable for ZX-G 620 accumulator.
	<b>ZX-G 710</b>	Emergency exit set with relais, switch, battery and charger.
	<b>ZX-G 715</b>	Exchange accumulator for ZX-G 710 emergency exit set.

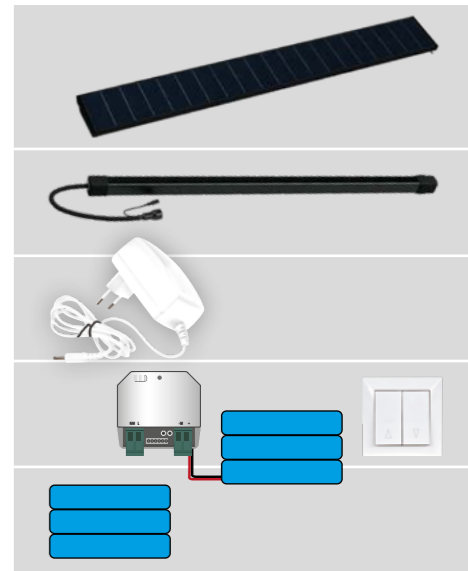

**SUITABLE ACCESSORIES**

CODE	DESCRIPTION	PAGE
<b>FX-S i</b>	Sun and wind controls	36
<b>FX-H i/W i</b>	Radio emitters unidirectional	37
<b>FX-I</b>	Smart-Home system	42
<b>ZX-K</b>	KLICK Installation System	50 - 53
<b>WX-F/V/Z</b>	Brackets	46 - 47
<b>AX-A/R</b>	Adapter-set	48 - 49



[WWW.ACOMAX.DE/VIDEOS#STEUERUNG](http://WWW.ACOMAX.DE/VIDEOS#STEUERUNG)



**THE FLEXIBLE VERSION - WITH PUSHBUTTON RADIO RECEIVER**

CODE	PRODUCT	DESCRIPTION
MX-Fi	<b>MX-Fi 413 Maxi</b>	Radio tubular motor 13 Nm, 14 rpm., 40 mm octagonal, 2,5 m cable, frequency 433,92 MHz bidirectional and standard engine mounts.
	<b>MX-Fi 520 Ultra</b>	Radio tubular motor 20 Nm, 15 rpm., 60 mm octagonal, 2,5 m cable, frequency 433,92 MHz bidirectional and standard engine mounts.
	<b>MX-Fi 540 Mega</b>	Radio tubular motor 40 Nm, 15 rpm., 60 mm octagonal, 2,5 m cable, frequency 433,92 MHz bidirectional and standard engine mounts.
	<b>MX-Fi 550 Giga</b>	Radio tubular motor 50 Nm, 12 rpm., 60 mm octagonal, 2,5 m cable, frequency 433,92 MHz bidirectional and standard engine mounts.



Further information can be found in our 200-page DIN-A 5 Motorization Manual, in the section Drives (you may request your personal copy for free).

Illustrations may include optional equipment. If requested, we will be happy to assemble the motor head you need (standard delivery: with square bolt).

**SUITABLE ACCESSORIES**

CODE	DESCRIPTION	PAGE
<b>FX-S i</b>	Sun and wind controls bidirectional	36
<b>FX-H i/W i</b>	Radio emitters bidirectional	37
<b>FX-I</b>	Smart-Home system	42
<b>ZX-K</b>	KLICK Installation System	50 - 53
<b>WX-F/V/Z</b>	Brackets	46 - 47
<b>AX-A/R</b>	Adapter-set	48 - 49



[WWW.ACOMAX.DE/VIDEOS#ANTRIEBE](http://WWW.ACOMAX.DE/VIDEOS#ANTRIEBE)



**THE SOLID VERSION - WITH MANUAL OVERRIDE**

CODE	PRODUCT	DESCRIPTION
MX-Nfi	<b>MX-Nfi 540 Mega</b>	Manual-radio tubular motor 40 Nm, 15 rpm, 60 mm octagonal, 2,5 m cable, frequency 433,92 MHz bidirectional and standard engine mounts.
	<b>MX-Nfi 550 Giga</b>	Manual-radio tubular motor 50 Nm, 12 rpm, 60 mm octagonal, 2,5 m cable, frequency 433,92 MHz bidirectional and standard engine mounts.
	<b>MX-Nfi 560 Terra</b>	Manual-radio tubular motor 60 Nm, 8 rpm, 60 mm octagonal, 2,5 m cable, frequency 433,92 MHz bidirectional and standard engine mounts.
	<b>MX-Nfi 680 Xeno</b>	Manual-radio tubular motor 80 Nm, 12 rpm, 70 mm octagonal, 2,5 m cable, frequency 433,92 MHz bidirectional and standard engine mounts.



Further information can be found in our 200-page DIN-A 5 Motorization Manual, in the section Drives (you may request your personal copy for free).

Illustrations may include optional equipment. If requested, we will be happy to assemble the motor head you need (standard delivery: with square bolt).

**MANUAL - EVERYTHING UNDER CONTROL**

CODE	PRODUCT	DESCRIPTION
ZX-N	<b>ZX-N 510 Eye</b>	7 mm hexagon 11,5 cm long
	<b>ZX-N 511 Eye</b>	7 mm hexagon 28 cm long
	<b>ZX-N 520 Joint</b>	7 mm hexagon 50 cm long
	<b>ZX-N 530 Hand crank</b>	Collapsible handle 145 cm long



**SUITABLE ACCESSORIES**

CODE	DESCRIPTION	PAGE
<b>FX-S i</b>	Sun and wind controls	36
<b>FX-H i/W i</b>	Radio emitters unidirectional	37
<b>FX-I</b>	Smart-Home system	42
<b>WX-F/V/Z</b>	Brackets	46 - 47
<b>AX-A/R</b>	Adapter-set	48 - 49



[WWW.ACOMAX.DE/VIDEOS#ANTRIEBE](http://WWW.ACOMAX.DE/VIDEOS#ANTRIEBE)



# I // RADIO MOTOR WITH WIFI RECEIVER MX-I

DRIVES WITH BIDIRECTIONAL RADIO RECEIVER



THE INNOVATIVE ONE – WITH BIDIRECTIONAL RADIO AND INTEGRATED WIFI RECEIVER

CODE	PRODUCT	DESCRIPTION
MX-i	MX-I 413 Maxi	Radio tubular motor 13 Nm, 14 rpm., 40 mm octagonal, 2,5 m cable, frequency 433,92 MHz bidirectional and standard engine mounts.
	MX-I 520 Ultra	Radio tubular motor 20 Nm, 15 rpm., 60 mm octagonal, 2,5 m cable, frequency 433,92 MHz bidirectional and standard engine mounts.
	MX-I 540 Mega	Radio tubular motor 40 Nm, 12 rpm., 60 mm octagonal, 2,5 m cable, frequency 433,92 MHz bidirectional and standard engine mounts.

Further information can be found in our 200-page DIN-A 5 Motorization Manual, in the section Drives (you may request your personal copy for free).

## SUITABLE ACCESSORIES

CODE	DESCRIPTION	PAGE
FX-S i	Sun and wind controls bidirectional	36
FX-H i/W i	Radio emitters bidirektional	37
FX-I	Smart-Home system	42
ZX-K	KLICK Installation System	50 – 53
WX-F/V/Z	Brackets	46 – 47
AX-A/R	Adapter-set	48 – 49



Illustrations may include optional equipment. If requested, we will be happy to assemble the motor head you need (standard delivery: with square bolt).



WWW.ACOMAX.DE/  
VIDEOS#ANTRIEBE

# Mf // RADIO MOTOR FOR AWNINGS MX-Mf

DRIVES WITH BIDIRECTIONAL RADIO RECEIVER



THE SPECIAL VERSION – FOR CLOSED AWNING SYSTEMS

CODE	PRODUCT	DESCRIPTION
MX-Mf	MX-Mf 540 Mega	Radio tubular motor 40 Nm, 15 rpm, 78 mm notch, 2,5 m cable, star-motorhead and WX-V 528 frequency 433,92 MHz bidirectional and standard engine mounts.
	MX-Mf 550 Giga	Radio tubular motor 50 Nm, 12 rpm, 78 mm notch, 2,5 m cable, star-motorhead and WX-V 528 frequency 433,92 MHz bidirectional and standard engine mounts.

Further information can be found in our 200-page DIN-A 5 Motorization Manual, in the section Drives (you may request your personal copy for free).

## SUITABLE ACCESSORIES

CODE	DESCRIPTION	PAGE
FX-S i	Sun and wind controls bidirectional	36
FX-H i/W i	Radio emitters bidirektional	37
FX-I	Smart-Home system	42
WX-F/V/Z	Brackets	46 – 47
AX-A/R	Adapter-set	48 – 49



Illustrations may include optional equipment. If requested, we will be happy to assemble the motor head you need (standard delivery: with square bolt).



WWW.ACOMAX.DE/  
VIDEOS#ANTRIEBE

# Zf // ELECTRONIC RADIO DRIVES FOR ZIP-SCREEN MX-Zf

DRIVES WITH BIDIRECTIONAL RADIO RECEIVER



**ELECTRONIC ZIP-DRIVES** are used to motorize so-called zipper shades, which are provided with a kind of zipper and therefore very stable in wind. The adjustment is made at the touch of a button or fully automatically. The drives are controlled by radio, and intelligent obstacle/wind detection is also integrated.

CODE	PRODUCT	DESCRIPTION
MX-Zf	<b>MX-Zf 510 Micro</b>	Elektronik-Funk ZIP Rohrantrieb 10 Nm, 15 U/Min., mit 78 mm Nutrohr Adapterset, 2,5 m Kabel und Stern-Motorlager
	<b>MX-Zf 530 Supra</b>	Elektronik-Funk ZIP Rohrantrieb 30 Nm, 15 U/Min., mit 78 mm Nutrohr Adapterset, 2,5 m Kabel und Stern-Motorlager

Further information can be found in our 200-page DIN-A 5 Motorization Manual, in the section Drives (you may request your personal copy for free).

## SUITABLE ACCESSORIES

CODE	DESCRIPTION	PAGE
<b>FX-S i</b>	Sun and wind controls bidirectional	36
<b>FX-H i/W i</b>	Radio emitters bidirektional	37
<b>FX-I</b>	Smart-Home system	42
<b>ZX-K</b>	KLICK Installation System	50 - 53
<b>WX-F/V/Z</b>	Brackets	46 - 47
<b>AX-A/R</b>	Adapter-set	48 - 49



Illustrations may include optional equipment. If requested, we will be happy to assemble the motor head you need (standard delivery: with square bolt).



[WWW.ACOMAX.DE/VIDEOS#ANTRIEBE](http://WWW.ACOMAX.DE/VIDEOS#ANTRIEBE)

# Ga // DC MOTORS MX-Ga

DRIVES WITH BIDIRECTIONAL RADIO RECEIVER



**DC MOTORS** with integrated Battery and radio receivers are even easier to install. Charge them either occasionally via power adapter or permanently via solar panel.

CODE	PRODUCT	DESCRIPTION
MX-Ga	<b>MX-Ga 413 Maxi</b>	Gleichstrom Rohrantrieb 13 Nm, 13 U/Min., mit 40 mm Achtkant mit 2,5 m Kabel und Steckerverbindung für den ZX-G 620 Akku.
	<b>MX-Ga 520 Ultra</b>	Gleichstrom Rohrantrieb 20 Nm, 10 U/Min., mit 60 mm Achtkant mit 2,5 m Kabel und Steckerverbindung für den ZX-G 620 Akku.

Further information can be found in our 200-page DIN-A 5 Motorization Manual, in the section Drives (you may request your personal copy for free).



Illustrations may include optional equipment. If requested, we will be happy to assemble the motor head you need (standard delivery: with square bolt).

CODE	PRODUCT	DESCRIPTION
ZX-G	<b>ZX-G 610</b>	Solar panel dimensions 455 x 60 x 10 mm.
	<b>ZX-G 650</b>	Battery charger with 1,5 m cable for ZX-G 620 accumulator.

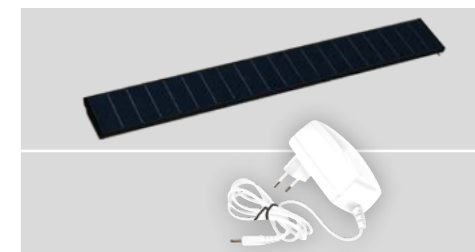

## SUITABLE ACCESSORIES

CODE	DESCRIPTION	PAGE
<b>FX-S i</b>	Sun and wind controls bidirectional	36
<b>FX-H i/W i</b>	Radio emitters bidirektional	37
<b>FX-I</b>	Smart-Home system	42
<b>ZX-K</b>	KLICK Installation System	50 - 53
<b>WX-F/V/Z</b>	Brackets	46 - 47
<b>AX-A/R</b>	Adapter-set	48 - 49



[WWW.ACOMAX.DE/VIDEOS#ANTRIEBE](http://WWW.ACOMAX.DE/VIDEOS#ANTRIEBE)



[WWW.ACOMAX.DE/MEDIA/RX-S\\_ANLEITUNG.PDF](http://WWW.ACOMAX.DE/MEDIA/RX-S_ANLEITUNG.PDF)

# RADIO CONTROLS

## ROLLER SHUTTER SUNPROTECTION RADIO



### SWITCHES – EVERYTHING UNDER CONTROL

CODE	PRODUCT	DESCRIPTION
CX-G	CX-G 210 Solo	Group control
RX-S	RX-S 015 Programming cable	With switch and programming button
	RX-S 010 Rocker switch	For MX-I motors
	RX-S 020 Turn switch	Flush-mounted
	RX-S 030 Turn switch incl. base plate	Surface mounted
	RX-S 040 Permanent switch UP/STOP/DOWN	Flush-mounted
	RX-S 050 Permanent switch UP/STOP/DOWN	Flush-mounted
	RX-S 060 Water resistant switch IP44	IP44 splash-proof, surface mounted
	RX-S 070 Key switch	Surface mounted, 2 keys
RX-R	RX-R 090 Single frame	For RX-S 010/020/040/050, RX-T 140.
	RX-R 092 Single frame	For RX-T 110
	RX-R 099 intermediate frame	Intermediate frame for RX-R 102/103
	RX-R 102 Double frame	For RX-S 010/020/040/050, RX-T 140
	RX-R 103 Triple frame	For RX-S 010/020/040/050, RX-T 140
RX-T	RX-T 110 Eco	Timer with daily program
	RX-T 140 Prestige	Time switch with day- and week-program with additional functions
	RX-T 145 Sensor	Sun- and light-sensor for RX-T 140 Prestige





### WEATHER SENSITIVE – DEPENDING ON SUN AND WIND



CODE	PRODUCT	DESCRIPTION
FX-S i	<b>FX-S 320 i Wind sensor</b>	Radio wind sensor, 433,92 MHz.
	<b>FX-S 330 i Sun sensor</b>	Radio sun sensor for windows, 433,92 MHz.
	<b>FX-S 350 i Solar</b>	Solar sun and wind control system, 433,92 MHz, incl. FX-H 421 i 1-channel emitter.

Further information can be found in our 200-page DIN-A 5 Motorization Manual, in the section Drives (you may request your personal copy for free).

### LATER INSTALLATION – IT IS NEVER TOO LATE FOR RADIO

CODE	PRODUCT	DESCRIPTION
FX-E i	<b>FX-E 410 i Receiver</b>	Radio receiver 433,92 MHz.
	<b>FX-E 411 i Connector receiver</b>	Radio connector 433,92 MHz for Hirschmann-connector.
	<b>FX-E 412 i Concealed receiver</b>	Radio receiver 433,92 MHz
	<b>FX-E 413 i Light actuator</b>	Radio receiver for light applications 433,92 MHz
	<b>FX-E 450 i Repeater</b>	Repeater 433,92 MHz

Further information can be found in our 200-page DIN-A 5 Motorization Manual, in the section Drives (you may request your personal copy for free).

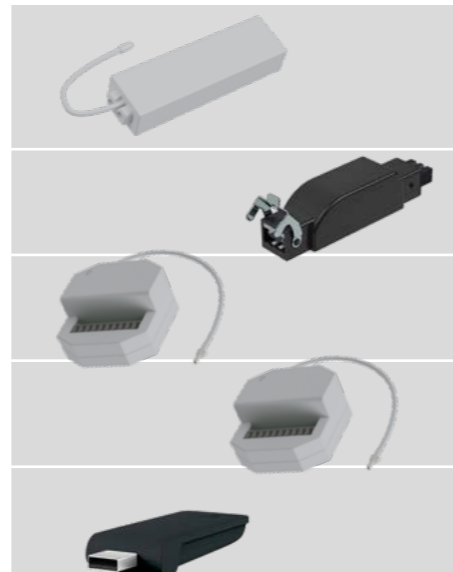

### MODERN DESIGN – NICE AND USEFUL



CODE	PRODUCT	DESCRIPTION
FX-H i	<b>FX-H 420 i 1-channel</b>	Key-chain emitter, 433,92 MHz.
	<b>FX-H 421 i 1-channel</b>	Portable emitter, 433,92 MHz.
	<b>FX-H 425 i 1-15-channel</b>	Portable emitter, 433,92 MHz.
	<b>FX-H 461 i 1-channel timer</b>	Portable emitter, timer, 433,92 MHz.
	<b>FX-H 465 i 5-channel timer</b>	Portable emitter, timer, 433,92 MHz.

Further information can be found in our 200-page DIN-A 5 Motorization Manual, in the section Drives (you may request your personal copy for free).

### SUITABLE – STAND ALONE OR TOGETHER WITH OTHER SWITCHES

CODE	PRODUCT	DESCRIPTION
FX-W i	<b>FX-W 481 i 1-channel</b>	Wall mounted emitter, 433,92 MHz.
	<b>FX-W 485 i 1-15-channel</b>	Wall mounted emitter, 433,92 MHz.
	<b>FX-W 491 i 1-channel timer</b>	Wall mounted emitter, timer, 433,92 MHz.
	<b>FX-W 495 i 5-channel timer</b>	Wall mounted emitter, timer, 433,92 MHz.

Further information can be found in our 200-page DIN-A 5 Motorization Manual, in the section Drives (you may request your personal copy for free).

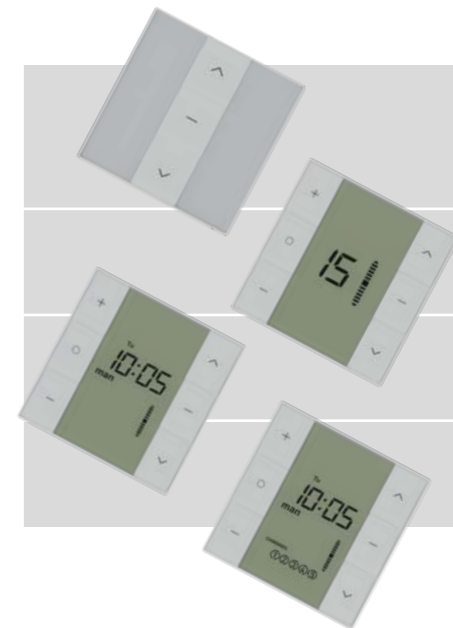
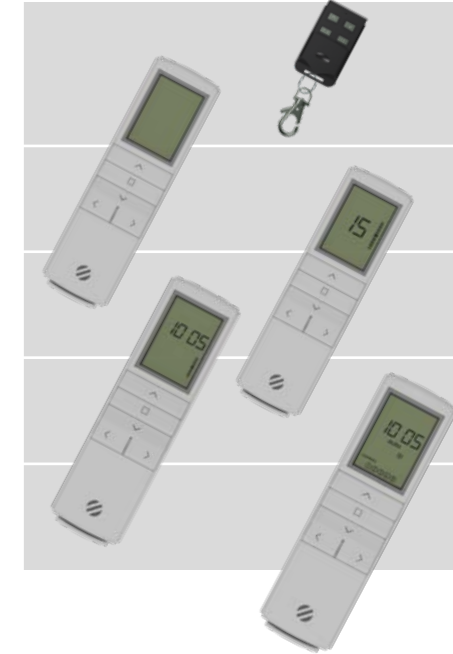

# SMART HOME

FOR MORE COMFORT  
AND SAFETY



## SMARTCONTROL PLUS DIAGRAM FX-I 600 OPERATING PRINCIPLE

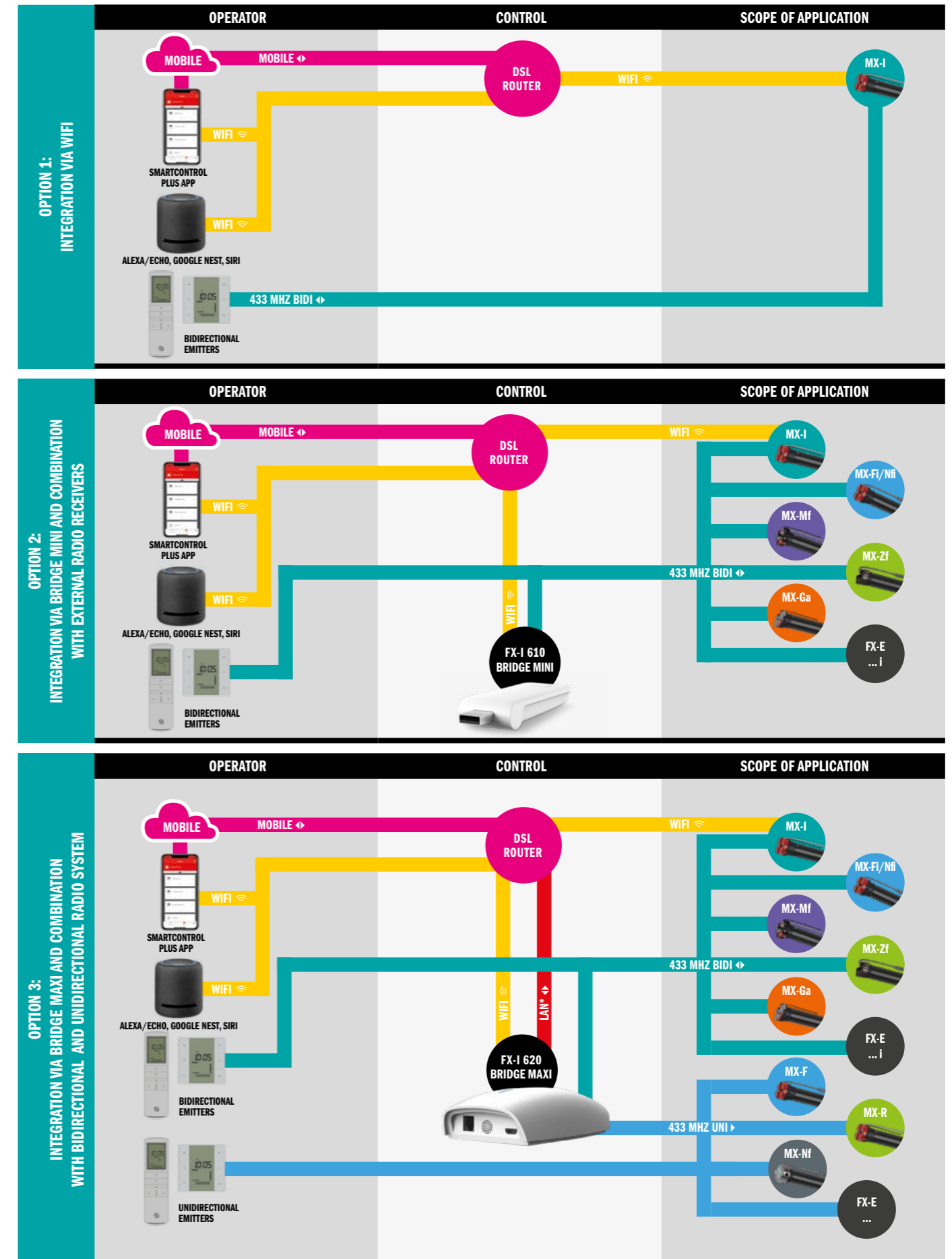

**ADVICE**  
The integration of other trades via Alexa/Echo, Google Nest and Siri is possible.

\*Power plug and network cable are not included in the scope of delivery.

## COMPATIBILITY OF UNIDIRECTIONAL PRODUCTS

	DSL-Router on site	FX-I 610 Bridge Mini	FX-I 620 Bridge Maxi
<b>Receivers</b>			
FX-E 410	-	-	•
FX-E 411	-	-	•
FX-E 412	-	-	•
FX-E 413	-	-	-
ZX-G 620 AKKU	-	-	•
<b>Motors</b>			
MX-F	-	-	•
MX-M	-	-	•
MX-R	-	-	•
MX-Nf	-	-	•
<b>Emitter</b>			
FX-H 421 + 425	-	-	-
FX-H 461-469	-	-	-
FX-W 481-485	-	-	-
FX-W 491-499	-	-	-
<b>Sun controls</b>			
FX-S 320	-	-	-
FX-S 330	-	-	-
FX-S 350	-	-	-

compatible • not compatible -

## COMPATIBILITY OF BIDIRECTIONAL PRODUCTS

	DSL-Router on site	FX-I 610 Bridge Mini	FX-I 620 Bridge Maxi
<b>Receivers</b>			
FX-E 410 i	-	•	•
FX-E 411 i	-	•	•
FX-E 412 i	-	•	•
FX-E 413 i	-	-	-
ZX-G 620 AKKU	-	•	•
<b>Motors</b>			
MX-Fi	-	•	•
MX-Nfi	-	•	•
MX-Mf	-	•	•
MX-I	•	•	•
MX-Zf	-	•	•
MX-Ga	-	•	•
<b>Emitter</b>			
FX-H 421 + 425 i	-	-	-
FX-H 461 + 465 i	-	-	-
FX-W 481 + 485 i	-	-	-
FX-W 491 + 495 i	-	-	-
<b>Sun controls</b>			
FX-S 320 i	-	-	-
FX-S 330 i	-	-	-
FX-S 350 i	-	-	-

compatible • not compatible -



SMART HOME - FOR A CONNECTED HOME



WWW.ACOMAX.DE/  
VIDEOS#SMART-HOME

FX-I 600

CODE	PRODUCT	DESCRIPTION
FX-I	FX-I 610 Bridge Mini	For bidirectional products
	FX-I 620 Bridge Maxi	For bi- and unidirectional products
	FX-I 630 App	SmartControl PLUS
	FX-I 650 Power supply	For Bridge Mini and Maxi



FX-I 630 APP FUNCTION

Control your shading system conveniently via smartphone, using our **acomax SmartControl PLUS** app. For installation in connection with the **acomax SmartControl PLUS** app you do not need any further components when using the MX-I drive. Otherwise only the **FX-I 610 Bridge Mini** or, if you are already using unidirectional acomax products, the **FX-I 620 Bridge Maxi** is needed.

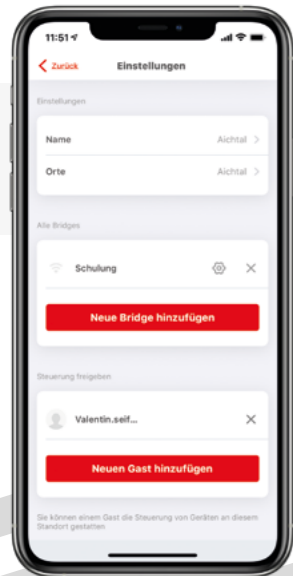

LOCATION AND GUEST FUNCTION

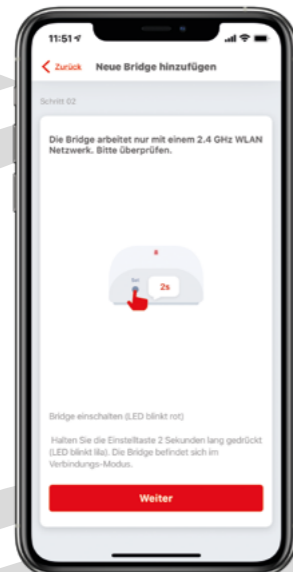

ADD NEW BRIDGE

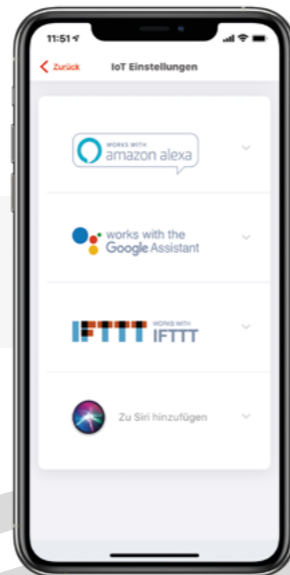

CROSS-PLATFORM LINKS

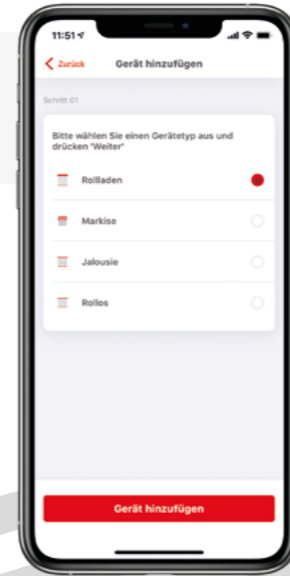

ADD NEW DEVICES

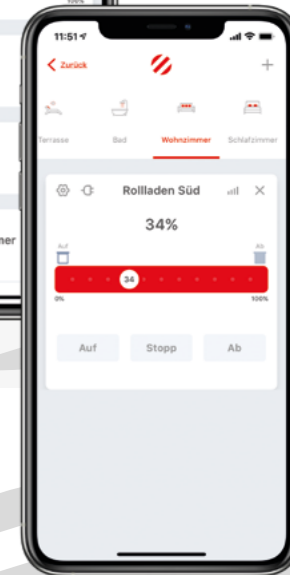
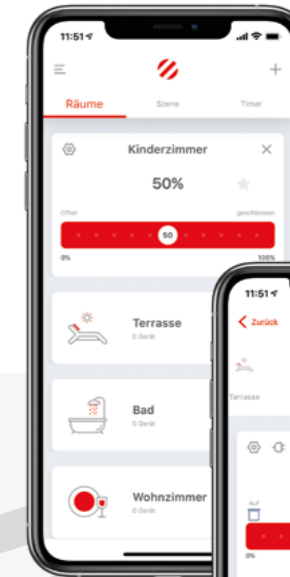

CREATE AND CONTROL ROOMS

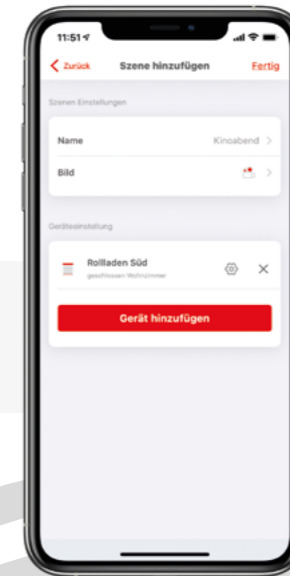

CREATE SCENES

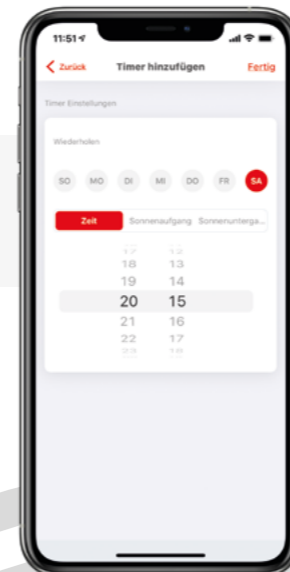

ADD TIMERS

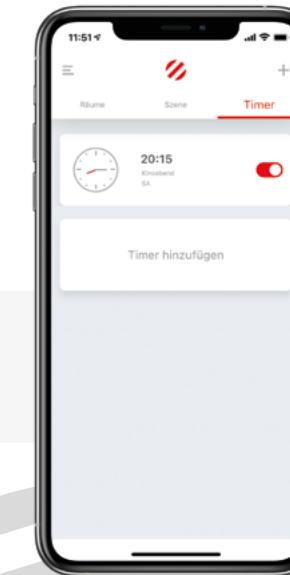

AUTOMATE DEVICES AND SCENES WITH TIMER

# INNOVATIVE ACCESSORIES

FOR SUPER FAST  
ASSEMBLY

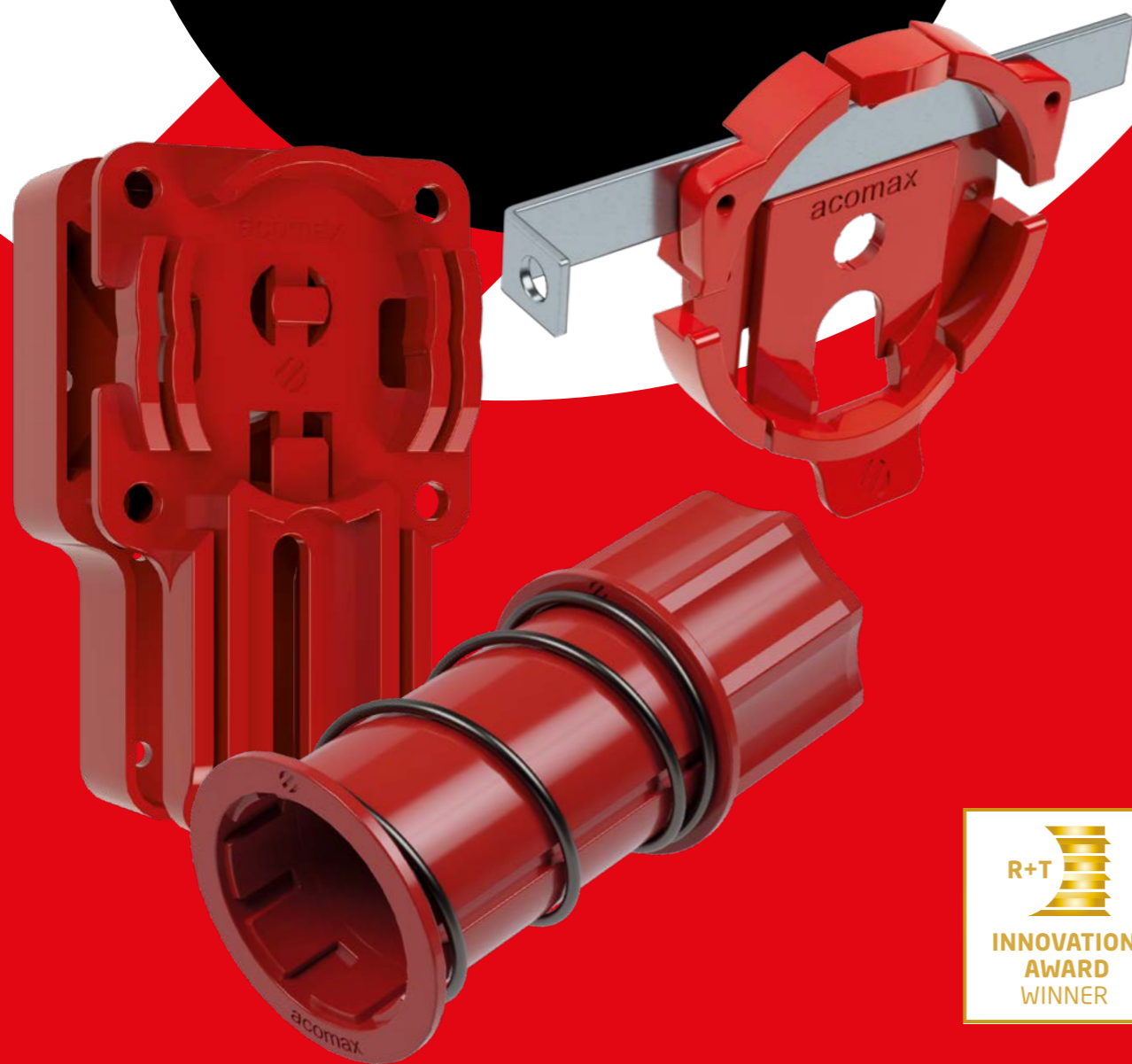

**NEW**  
FAST-MOUNTING-SET  
NOW FITTING ALL  
ROLLER SHUTTER  
BOXES

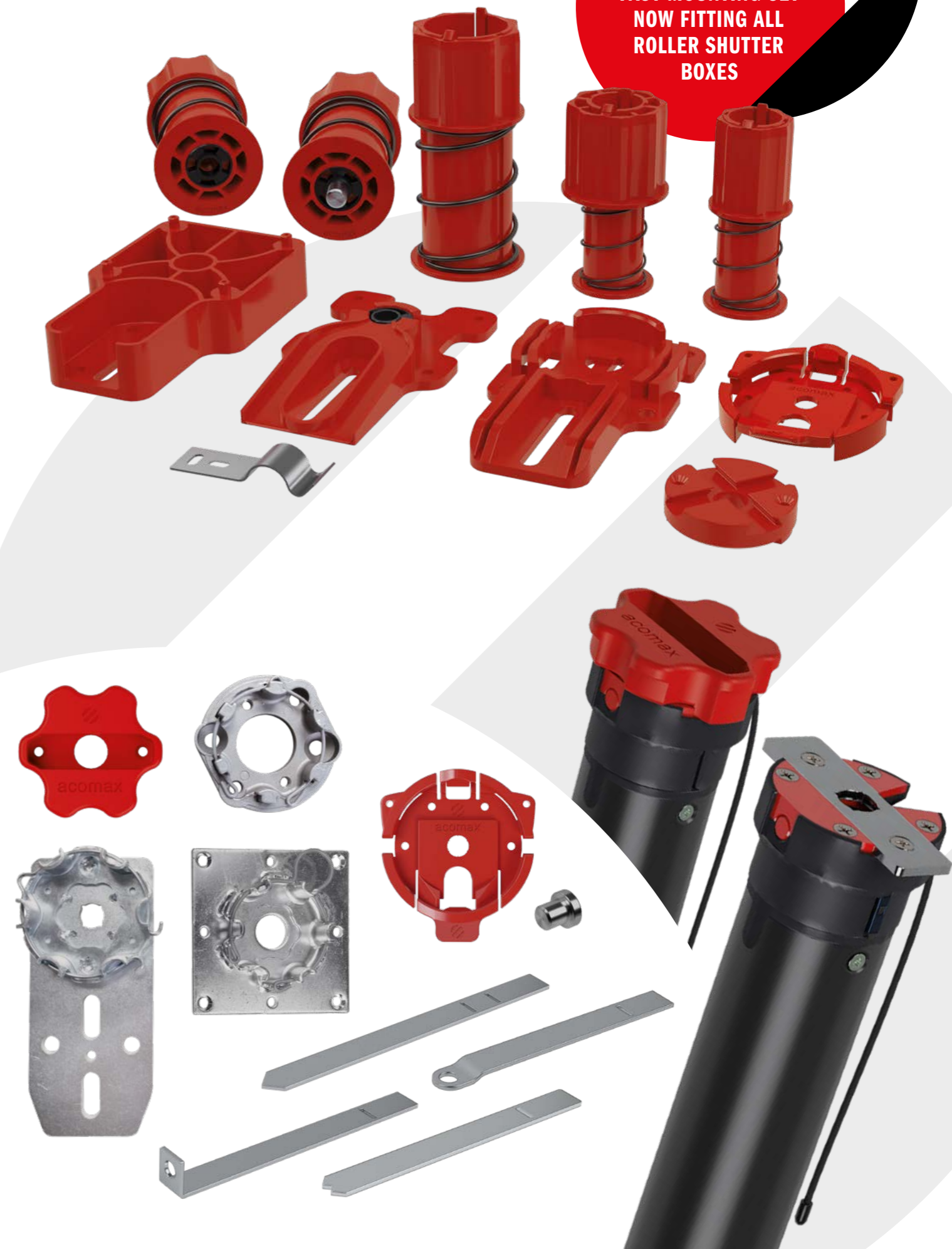



WWW.ACOMAX.DE/  
VIDEOS#KLICK

FAST AND EASY ASSEMBLY IN WALL INTEGRATED SHUTTER BOXES

CODE	PRODUCT	DESCRIPTION
WX-F	<b>WX-F 100 KLIK</b> <b>ATTENTION</b> Only for shaft length of max. 220 cm and max. 2 pcs per side	Space reducer for deep boxes, with a depth of 30 mm, for WX-F 500
	<b>WX-F 500 KLIK</b>	Fast and easy engage and disengage KLIK bracket
	<b>WX-F 511 Universal</b>	Disengage bracket
	<b>WX-F 528 Star shape</b>	For star shaped motorhead
	<b>WX-F 531 Stick</b>	Bracket
	<b>WX-F 532 Star</b>	Bracket
	<b>WX-F 533 U shape</b>	Bracket

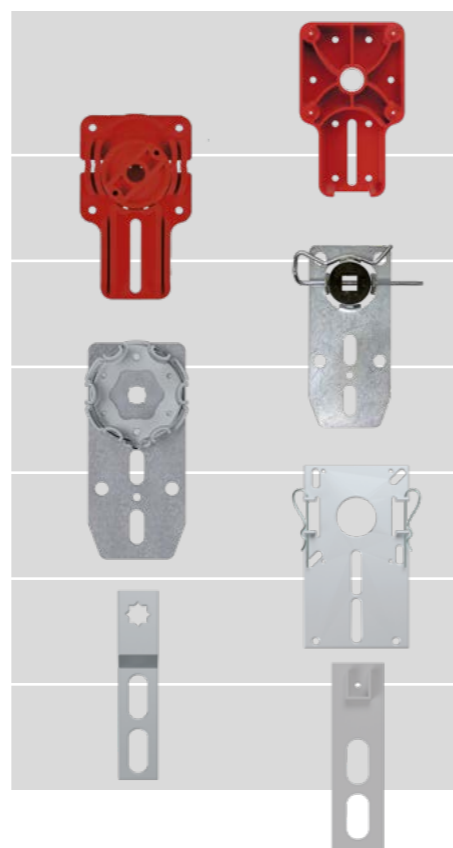

CODE	PRODUCT	DESCRIPTION
WX-V	<b>WX-V 505 KLIK</b>	Snap-in and easy disengagable bracket for front mounted shutter boxes
	<b>WX-V 506 Angle</b>	Snap-in and easy disengagable bracket for front mounted shutter boxes
	<b>WX-V 507 Slide</b> <b>ATTENTION</b> Only for drives up to a max. 20 NM	Snap-in and easy disengagable bracket for front mounted shutter boxes
	<b>WX-V 508 Heroal</b>	Snap-in and easy disengagable bracket for front mounted shutter boxes
	<b>WX-V 509 Carve</b> <b>ATTENTION</b> Only for drives up to a max. 20 NM	Snap-in and easy disengagable bracket for front mounted shutter boxes
	<b>WX-V 520 Stick</b>	Metal bracket
	<b>WX-V 528 Star</b>	For star shaped motorhead

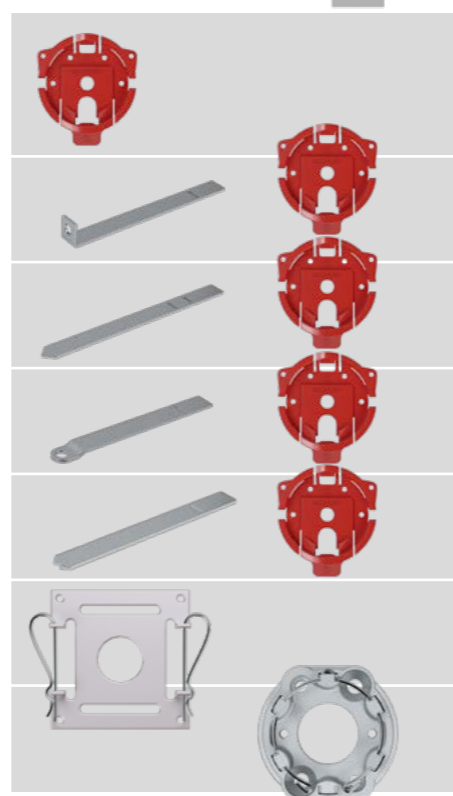

UNIVERSAL – FOR EVERY SITUATION A SUITABLE SOLUTION



WWW.ACOMAX.DE/  
VIDEOS#KLICK

CODE	PRODUCT	DESCRIPTION
WX-Z	<b>WX-Z 505 Cone</b>	Snap-in and easy disengagable bracket for front mounted shutter boxes
	<b>WX-Z 510 Standard</b>	Universal bracket
	<b>WX-Z 528 Star</b>	For star shaped motorhead
	<b>WX-Z 535 Stick</b>	Top box bracket
	<b>WX-Z 540 Renovation</b>	Clamp bracket
	<b>WX-Z 550 Fixing plate</b>	Universal design, 100 x 100 mm
	<b>WX-Z 610 Standard</b>	Bracket for MX 6
	<b>WX-Z 648 Flat</b>	Bracket for MX 6

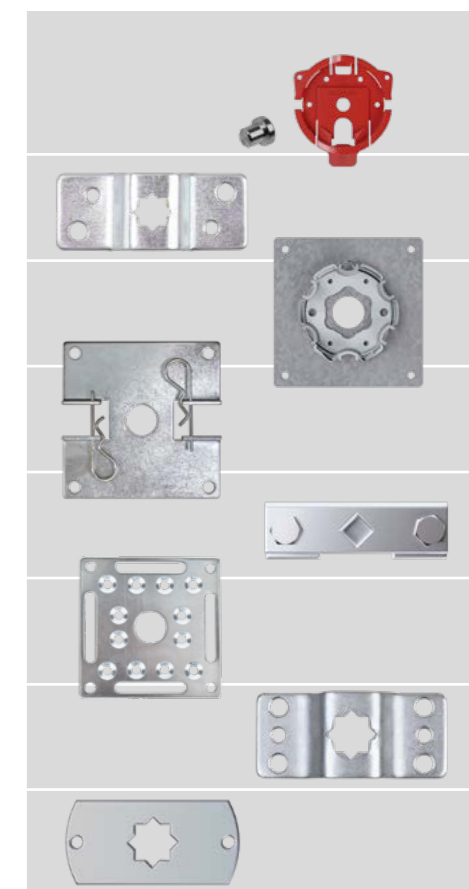



SUITABLE - FOR ALL COMMON TUBES SHAPES AND DIMENSIONS



CODE	PRODUCT	DESCRIPTION
AX-A	AX-A 451 Fixing element	To eliminate the 30 degrees clearance of the octagonal clutch required for obstacle recognition, to prevent jerking in heavy tanks
	AX-A 440 Octagonal	40 mm octagonal for MX-4 motors
	AX-A 550 Octagonal	50 mm octagonal for MX-4/5 motors
	AX-A 560 Octagonal	60 mm octagonal for MX-4/5 motors
	AX-A 570 Octagonal	70 mm octagonal for MX-4/5 motors
	AX-A 670 Octagonal	70 mm octagonal for MX-6 motors

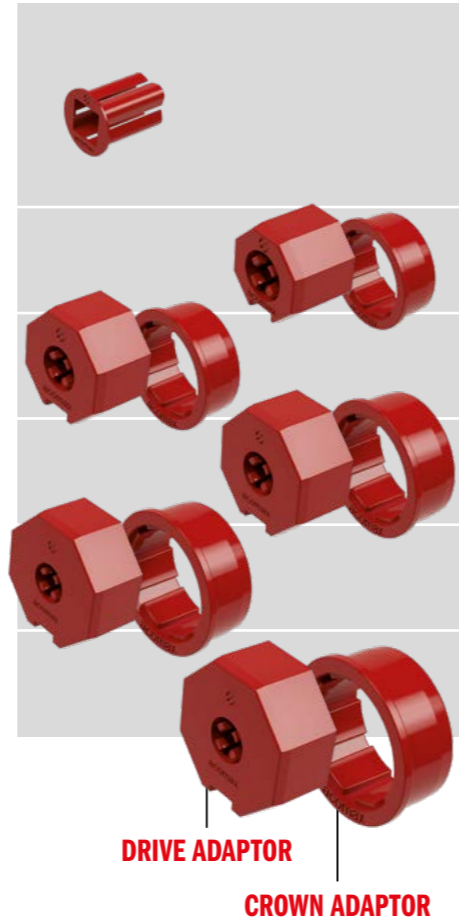

SUITABLE - FOR ALL COMMON TUBES SHAPES AND DIMENSIONS



CODE	PRODUCT	DESCRIPTION
AX-R	AX-R 450 Reduction ring	Limit switch intermediate ring MX-4/5
	AX-R 551 Round	50 mm round for MX-4/5 motors
	AX-R 561 Round	60 mm round for MX-4/5 motors
	AX-R 563 Notch	63 mm notch for MX-4/5 motors
	AX-R 565 Profile	65 mm profile for MX-4/5 motors
	AX-R 571 Round	70 mm round for MX-4/5 motors
	AX-R 572 Notch	70 mm notch for MX-4/5 motors
	AX-R 578 Notch	78 mm notch for MX-4/5 motors
	AX-R 585 Notch	85 mm notch for MX-4/5 motors
	AX-R 650 Reduction ring	Limit switch intermediate ring MX-6/7
	AX-R 671 Round	70 mm round for MX-6 motors
	AX-R 678 Notch	78 mm notch for MX-6 motors
	AX-R 685 Notch	85 mm notch for MX-6 motors

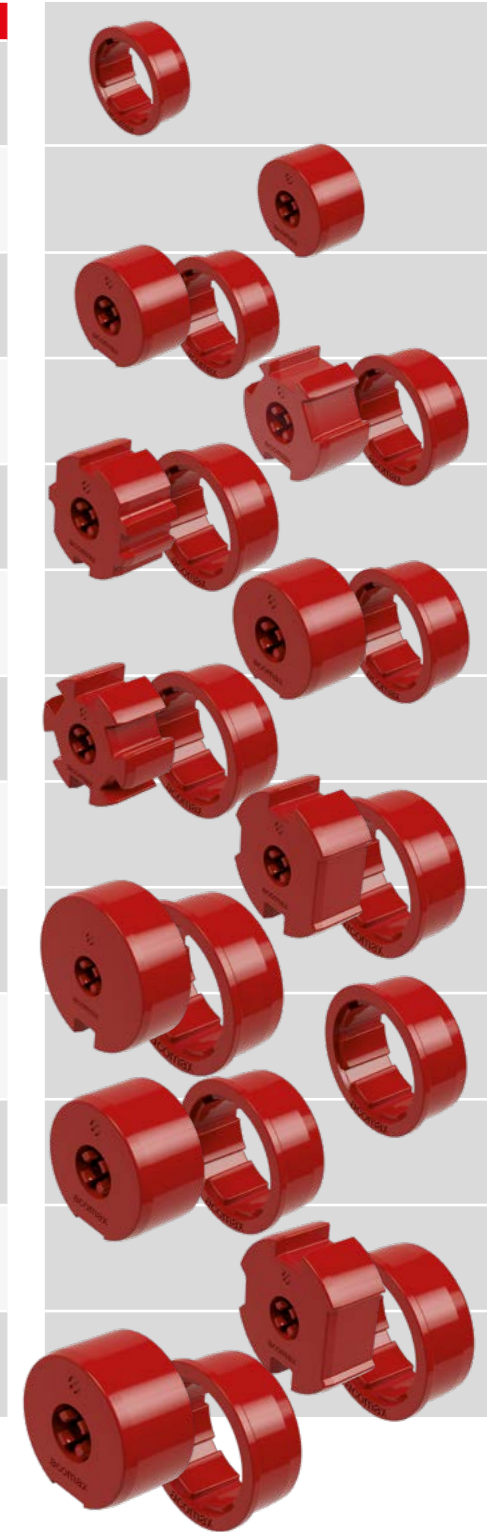

**KLICK ACCESSORIES FOR WALL INTEGRATED SHUTTER BOXES**

The innovative mounting system for wall integrated shutter boxes essentially ensures that a motorized roller shutter shaft can be installed and removed within a few seconds and without any tools.



WWW.ACOMAX.DE/  
VIDEOS#KLICK

CODE	PRODUCT	DESCRIPTION
WX-F	<b>WX-F 100 Spacer</b> <b>ATTENTION</b> Only for shaft length of max. 220 cm and max. 2 pcs per side	Space reducer for deep boxes, with a depth of 30 mm
	<b>WX-F 500 KLICK</b>	Fast and easy engage and disengage bracket for wall integrated shutter boxes
ZX-K	<b>ZX-K 560 KLICK Spring Idler 60 mm Octagonal</b>	Spring crown adapter with 7,5 cm telescope range, 60 mm octagonal
	<b>ZX-K 640 KLICK Spring idler</b>	Counterpart/Idler with 4 cm telescope range, 40 mm octagonal and 12 mm bolt
	<b>ZX-K 650 KLICK Spring idler</b>	Counterpart/Idler with 4 cm telescope range, 50 mm octagonal and 12 mm bolt
	<b>ZX-K 660 KLICK Spring idler</b>	Counterpart/Idler with 7,5 cm telescope range, 60 mm octagonal and 12 mm bolt
ZX-W	<b>ZX-W 130 KLICK Counterpart support</b>	Incl. ball bearing 12,3 mm



**ATTENTION**  
When using spring sleeves, the deduction dimension per sleeve increases by 50 mm (shorten the tube accordingly).

**FOR WALL INTEGRATED SHUTTER BOXES**

Shop for sets and save.



WWW.ACOMAX.DE/  
VIDEOS#KLICK

TUBE	BRACKET	SPRING CROWN	IDLER COUNTER-PART	WALL BRACKET
<b>ZX-K F40 KLICK for wall integrated shutter boxes 40 mm octagonal</b>				
<b>40 mm octagonal</b>	WX-F 500	-	ZX-K 640	ZX-W 130
<b>ZX-K F50 KLICK for wall integrated shutter boxes 50 mm octagonal</b>				
<b>50 mm octagonal</b>	WX-F 500	-	ZX-K 650	ZX-W 130
<b>ZX-K F60 KLICK for wall integrated shutter boxes 60 mm octagonal</b>				
<b>60 mm octagonal</b>	WX-F 500	ZX-K 560	ZX-K 660	ZX-W 130

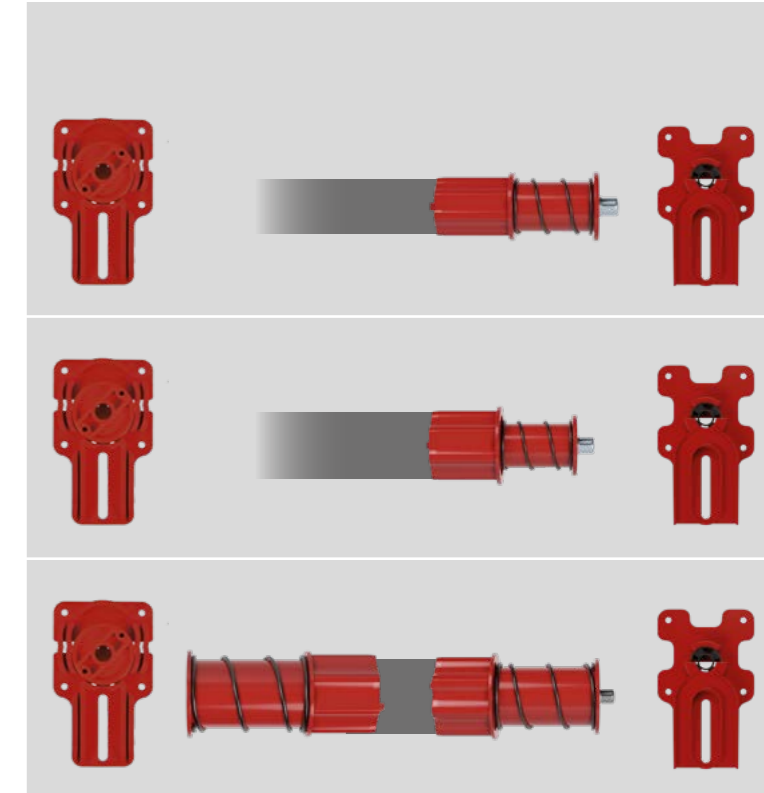

**ATTENTION**  
Shafts are not included.

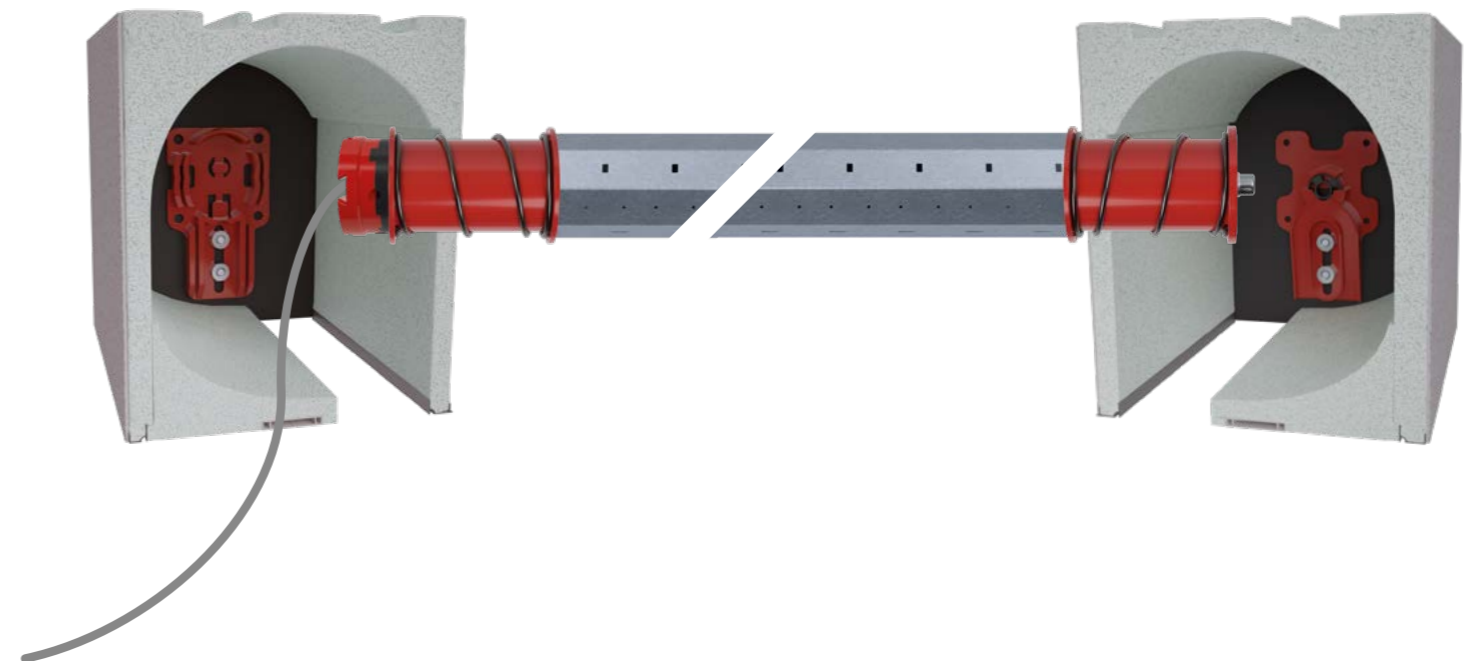



WWW.ACOMAX.DE/  
VIDEOS#KLICK

**KLICK ACCESSORIES FOR FRONT MOUNTED SHUTTER BOXES**

The innovative mounting system for external mounted shutter boxes essentially ensures that a motorized roller shutter shaft can be installed and removed within a few seconds and without any tools.

CODE	PRODUCT	DESCRIPTION
WX-V	<b>WX-V 505 KLICK</b>	Snap-in and easy disengagable bracket for front mounted shutter boxes
	<b>WX-V 506 Winkel</b>	Snap-in and easy disengagable bracket for front mounted shutter boxes
	<b>WX-V 507 Arrowhead</b> <b>ATTENTION</b> Only for drives up to a max. 20 NM	Snap-in and easy disengagable bracket for front mounted shutter boxes
	<b>WX-V 508 Heroal</b>	Snap-in and easy disengagable bracket for front mounted shutter boxes
	<b>WX-V 509 Carve</b> <b>ATTENTION</b> Only for drives up to a max. 20 NM	Snap-in and easy disengagable bracket for front mounted shutter boxes
WX-Z	<b>WX-Z 505 Bolt</b>	Snap-in and easy disengagable bracket for front mounted shutter boxes
ZX-K	<b>ZX-K 740 KLICK Spring idler</b>	Idler/Opposite side with 10/12 mm ball bearings and 4 cm telescope range, 40 mm octagonal
	<b>ZX-K 750 KLICK Spring idler</b>	Idler/Opposite side with 10/12 mm ball bearings and 4 cm telescope range, 50 mm octagonal
	<b>ZX-K 760 KLICK Spring idler</b>	Idler/Opposite side with 10/12 mm ball bearings and 7,5 cm telescope range, 60 mm octagonal

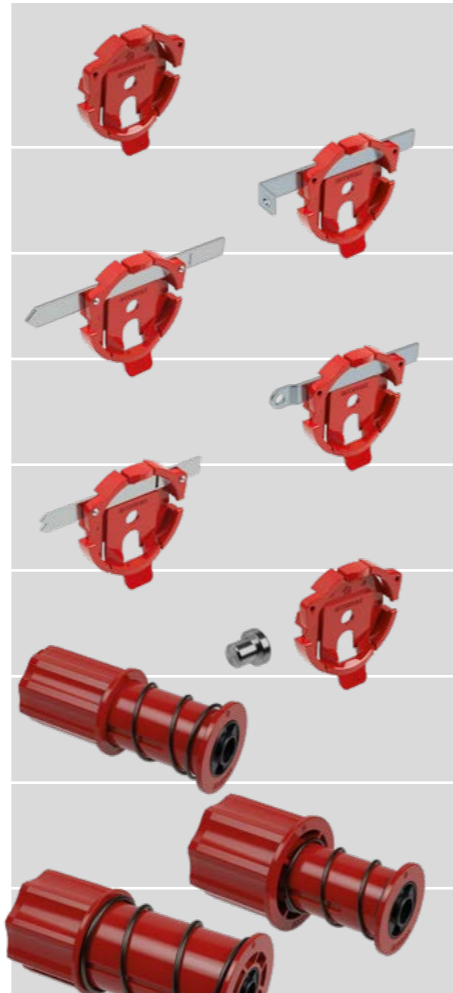

**ATTENTION**  
When using spring sleeves, the deduction dimension per sleeve increases by 50 mm (shorten the tube accordingly).

CODE	PRODUCT	DESCRIPTION
ZX-V	<b>ZX-V 506 Mounting Clip Angle</b>	Angle for lateral mounting
	<b>ZX-V 507 Mounting Clip Arrowhead</b>	Slide for clamp mounting
	<b>ZX-V 508 Mounting Clip Heroal</b>	Bracketed for heroal boxes
	<b>ZX-V 509 Mounting Clip Carve</b>	Slide for clamp mounting, for round shutter boxes
ZX-Z	<b>WX-Z 505 Mounting Clip Bolt</b>	Cone for universal mounting

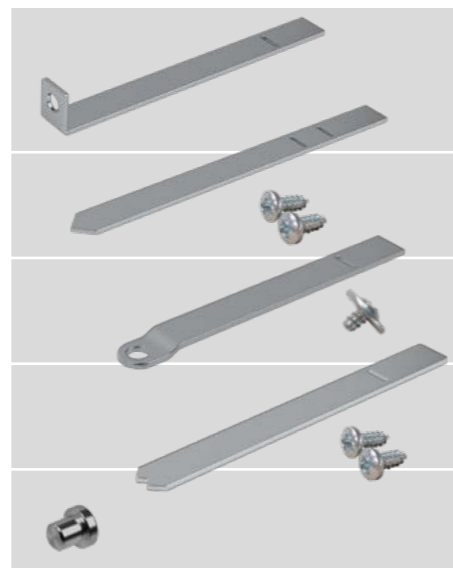

WWW.ACOMAX.DE/  
VIDEOS#KLICK

**FOR FRONT MOUNTED SHUTTER BOXES**

Shop for sets and save.

TUBE	BRACKET	SPRING CROWN	IDLER COUNTER-PART
<b>ZX-K V40 for external mounted shutter boxes 40 mm octagonal</b>			
<b>40 mm octagonal</b>	WX-V 505	-	ZX-K 740
<b>ZX-K V50 for external mounted shutter boxes 50 mm octagonal</b>			
<b>50 mm octagonal</b>	WX-V 505	-	ZX-K 750
<b>ZX-K V60 for external mounted shutter boxes 60 mm octagonal</b>			
<b>60 mm octagonal</b>	WX-V 505	-	ZX-K 760

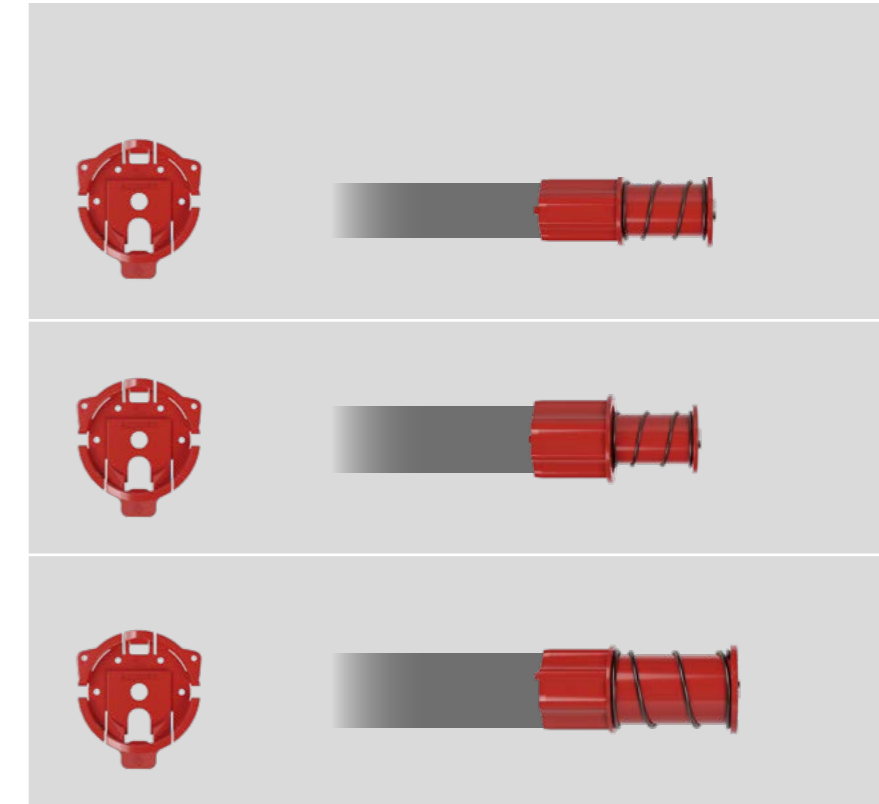

**ATTENTION**  
Shafts are not included.

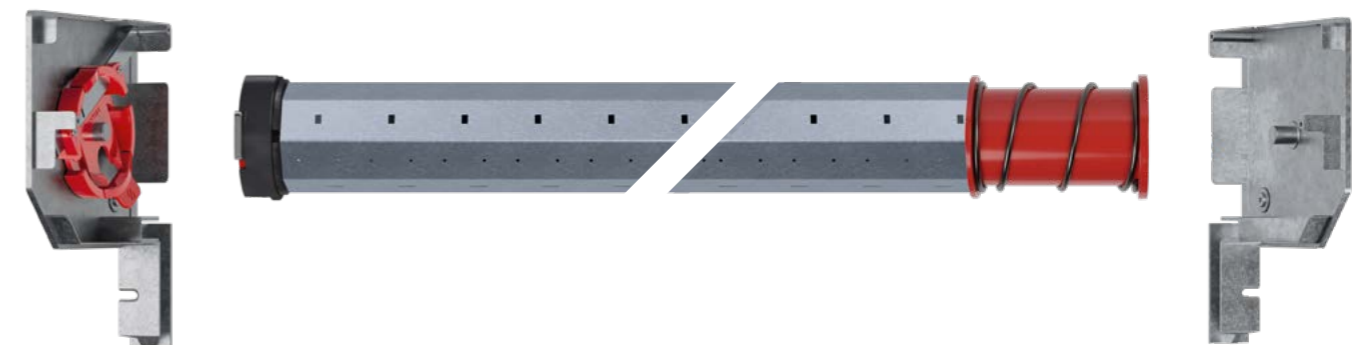



EXTENSIVE – ALWAYS THE SUITABLE SOLUTION



WWW.ACOMAX.DE/  
PRODUKTE/ZUBE-  
HOER/ZX-E-ELEKTRO-  
ZUBEHOER/

CODE	PRODUCT	DESCRIPTION
ZX-Z	ZX-Z 110 Setting tool red	Flexible limit setting tool , red
	ZX-Z 111 Setting tool white	Flexible limit setting tool, white
	ZX-Z 120 Pin	Pin for axial fixation of motor
	ZX-Z 510 Stern	Motor head disc
	ZX-Z 511 Plate for awning drives	Motor head with 10 x 10 mm squared bolt as an alternative for the star shaped motor head. Only use with MX-5 drives and max. 40 Nm.
	ZX-Z 512 Plate	Motor head with 12 x 16 squared bolt only for MX-4/5
	ZX-Z 516 Plate	Motor head with 16 x 16 squared bolt only for MX-4/5
	ZX-Z 520 Distance disk	Space disk for awnings for length compensation.

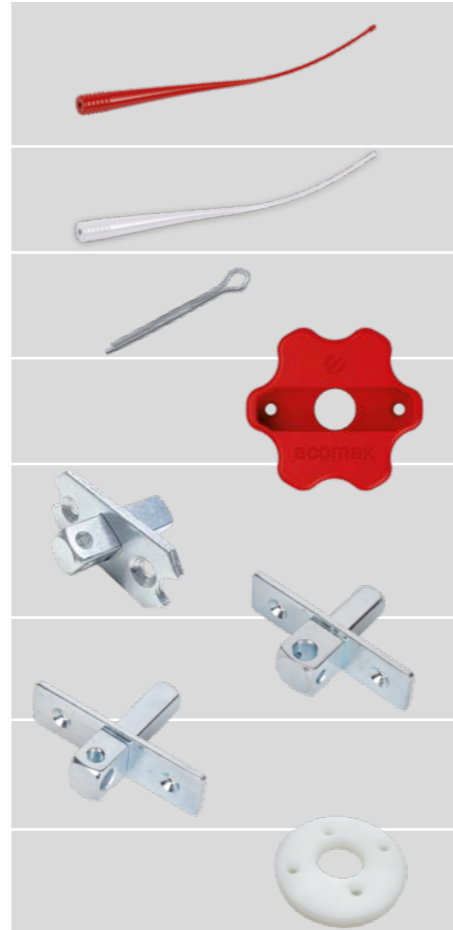

SOLID – EVERYTHING ON THE COUNTERPART



WWW.ACOMAX.DE/  
PRODUKTE/ZUBE-  
HOER/ZX-W-ZUBEHOER-  
FUER-WELLEN/

CODE	PRODUCT	DESCRIPTION
ZX-W	ZX-W 110 Tube clamp	For 40 mm octagonal tube
	ZX-W 120 Fixation spring	For a fast shutter fixation at the tube, 20 cm
	ZX-W 125 Lift stop	Solid connector with 3 slats
	ZX-W 129 Connector Maxi	For fixation lift stop with maxi shutter
	ZX-W 130 KLIICK Counterpart support	Incl. ball bearing 12,3 mm
	ZX-W 132 Counterpart support	Incl. ball bearing 12,3 mm
	ZX-W 135 Clamp bearing	Incl. ball bearing 12,3 mm
	ZX-W 140 Screw bearing mini	Incl. ball bearing 12,3 mm



PROVEN – FOR THE PERFECT ROTATION INSIDE THE SHUTTER BOX



WWW.ACOMAX.DE/  
PRODUKTE/ZUBE-  
HOER/ZX-W-ZUBEHOER-  
FUER-WELLEN/



CODE	PRODUCT	DESCRIPTION
ZX-W	ZX-W 240 Shutter tube	40 mm octagon piece 1,9 m.
	ZX-W 250 Shutter tube	50 mm octagon piece 1,9 m.
	ZX-W 260 Shutter tube	60 mm octagon piece 1,9 m.
	ZX-W 340 Telescope part	40 mm octagonal, with bolt 9,8 mm
	ZX-W 350 Telescope part	50 mm octagonal, with bolt 12 mm
	ZX-W 360 Telescope part	60 mm octagonal, with bolt 12 mm
	ZX-W 440 idler	40 mm octagonal, with bolt 9,8 mm
	ZX-W 450 idler	50 mm octagonal, with bolt 12 mm
	ZX-W 460 idler	60 mm octagonal, with bolt 12 mm

ELECTRICAL – EVERYTHING UNDER CONTROL



WWW.ACOMAX.DE/  
PRODUKTE/ZUBE-  
HOER/ZX-E-ELEKTRO-  
ZUBEHOER/

CODE	PRODUCT	DESCRIPTION
RX-S	RX-S 015 Programming cable	With switch and programming button
ZX-E	ZX-E 203 Battery CR 2032	Battery for sun sensor, 3 volt
	ZX-E 243 Battery CR 2430	Battery for wall emitter, 3 volt
	ZX-E 250 Battery AAA	Rollable white 15 x 15 lfm.
	ZX-E 210 Cable box	Rollable white 15 x 15 lfm.
	ZX-E 220 Connector set	Male and female
	ZX-E 230 Cable connector	4 pole
	ZX-E 310 Clip-Connector	3 pole, 50 pcs.
	ZX-E 360 Cable	For motor per m.
	ZX-E 380 Cable holder	For safe stowage of motor cable and antenna in the Roller shutter box
	ZX-E 235 Connection fee	Connection fee for cable connectors or cable plugs



acomax Service

MANUAL - EVERYTHING UNDER CONTROL

CODE	PRODUCT	DESCRIPTION
ZX-N	ZX-N 510 Eye	7 mm hexagon 11,5 cm long
	ZX-N 511 Eye	7 mm hexagon 28 cm long
	ZX-N 520 Joint	7 mm hexagon 50 cm long
	ZX-N 530 Hand crank	Collapsible handle 145 cm long



WWW.ACOMAX.DE/  
PRODUKTE/ZUBE-  
HOER/ZX-N-ZUBEHOER-  
NOTHANDANTRIEBE/

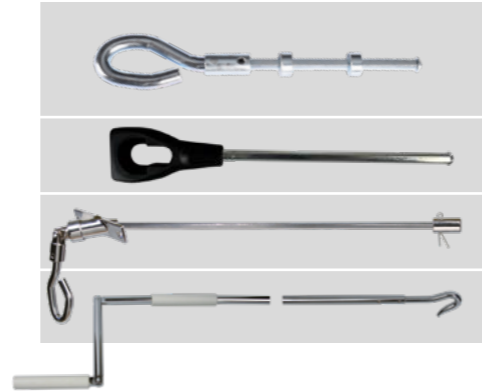

THE INDEPENDENT - FOR APPLICATIONS WITH 12 VOLT DC POWER SUPPLY

CODE	PRODUCT	DESCRIPTION
ZX-G	ZX-G 610	Solar panel dimensions 455 x 60 x 10 mm.
	ZX-G 620	Accumulator, 4.000 mAh with integrated radio receiver 433,92 MHz bidirectional dimensions 585 x 27 x 27
	ZX-G 650	Battery charger with 1,5 m cable for ZX-G 620 accumulator.
	ZX-G 710	Emergency exit set with relais, switch, battery and charger
	ZX-G 715	Exchange accumulator for ZX-G 710 emergency exit set



WWW.ACOMAX.DE/  
PRODUKTE/ZUBEHOER/  
ZX-G-ZUBEHOER-GLEICH-  
STROMANTRIEBE/

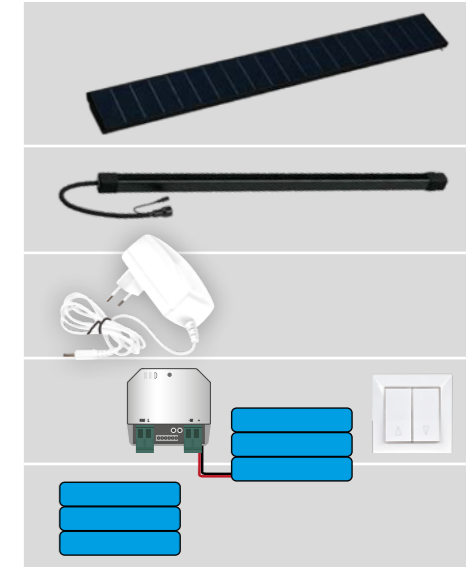



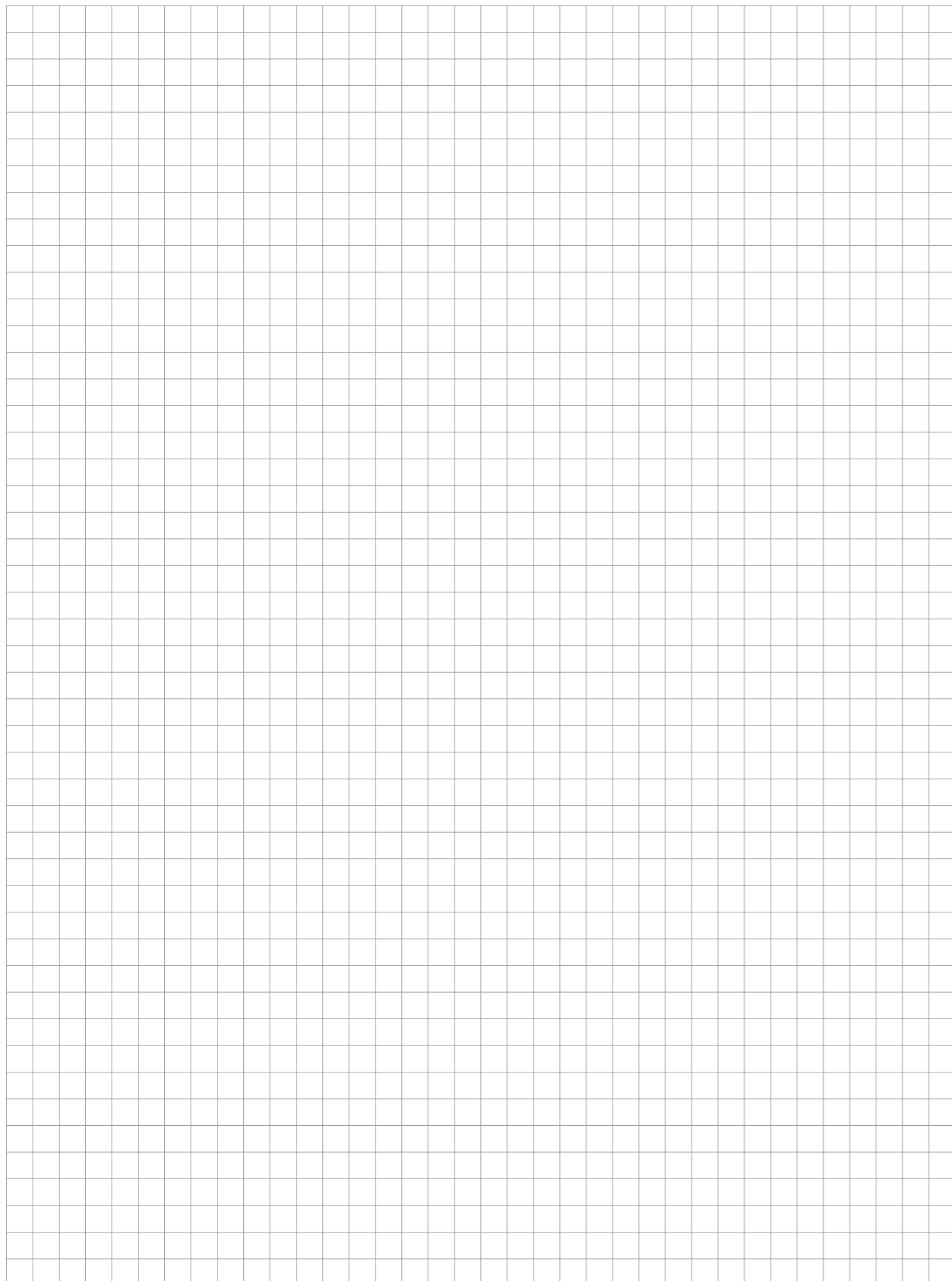

## YOUR DIRECT LINE TO US

REACHABLE 24 HOURS A DAY, 7 DAYS A WEEK



### THE MANUAL FOR PROFESSIONALS

Please feel free to order your manual here:  
[acomax.de/fachpartner/handbuch](http://acomax.de/fachpartner/handbuch)



### TELEPHONE SERVICE

We are reachable during office times from **Monday to Friday, 7:30 am to 4:30 pm**. Our team is available for you by calling the number **+49 7127 / 97 27 0-0**.

Listed below you can find the extension number to your personal contact:

- 11 Dr. Rolf W.-Seifart (CEO)
- 12 Linda Bartolcic (Office Management)
- 13 Jana Moldenhauer (Accounting)
- 14 Franziska Hoppe (Marketing)
- 15 Yasmin Ounifi (Sales)
- 16 Robert Popijac (Product manager)
- 17 Uli Hildenbrandt (Sales representative)
- 23 Valentin Seifart (Assistant to the CEO)
- 24 Anna Reichert (Sales representative)



### WHATSAPP

You can send pictures or information quickly via WhatsApp:  
**0151 / 64 95 63 46**.



### ONLINESHOP

Available 24/7 for our customers: [shop.acomax.de](http://shop.acomax.de)



### ORDER VIA FAX

Available 24/7 for our customers: **07127 / 97 27 0-20**



### E-MAIL CONTACT

A fast and easy way to reach out to us is by sending an email to [mail@acomax.de](mailto:mail@acomax.de). During office times you will receive response within one hour.



### VIDEOS

All important information available as short videos on our homepage around the clock, seven days a week. Everything explained simply, briefly and quickly. Use this new channel via our website or also on YouTube.



[acomax.de](http://acomax.de)



[shop.acomax.de](http://shop.acomax.de)



[facebook.com/  
acomax.gmbh](https://facebook.com/acomax.gmbh)



[acomax.de/downloads](http://acomax.de/downloads)



AGBs



**acomax.de**

